

RADIO'S GREATEST MAGAZINE

RADIO-CRAFT

Incorporating

RADIO & TELEVISION

HUGO GERNSBACK, Editor

**ARMY
"MOBILE"
RADIO**
See page 266

Hi-Freq. Converter

**Interference
Analysis**

**Kilowatt
Transmitter**

**School Sound
Systems**

**Photo-Coll
Relay**

**Speedy
Servicing**

**Radio In
Defense**



NOV. - DEC.

25¢

CANADA 30¢

1941

OVER 125 ILLUSTRATIONS

"Finest Dynamic I ever used"
 SAYS EVAN R. RUSHING, SOUND ENGINEER, HOTEL NEW YORKER

AMPERITE
P. G. DYNAMIC
 BRINGS STUDIO QUALITY
 TO ORDINARY P. A. JOBS

- **UNI-DIRECTIONAL.** NEW SUPERIOR ELIPSOID PICKUP PATTERN
- **ELIMINATES FEEDBACK** TROUBLE BECAUSE IT HAS LOWEST FEEDBACK POINT OF ALL DIAPHRAGM TYPE MICROPHONES
- **FLAT RESPONSE.** FREE FROM ANNOYING PEAKS, GIVING STUDIO-QUALITY REPRODUCTION.

The P.G. diaphragm follows air particle velocity where amplitude is a GRADIENT of the PRESSURE. In ordinary dynamics amplitude is restricted from following air particle velocity.

The P.G. DYNAMIC is a radical improvement in this type of microphone. You can actually hear the difference. Case is designed according to modern acoustic principles. Rugged, not affected by temperature, altitude or humidity. HAS UNUSUALLY HIGH OUTPUT. —55 DB.

MODEL PGH (PGL. 200 ohms). Excellent for high fidelity P.A. installations, broadcast studio, and professional recording. With switch, cable connector, 25' cable. Chrome finish. LIST \$32.00 (40-10 000 C.P.S.)

MODEL PGAH (PGAL. 200 ohms). For speech and music. 70-8000 C.P.S. Switch, cable connector, 12' cable. Chrome. LIST \$25.00

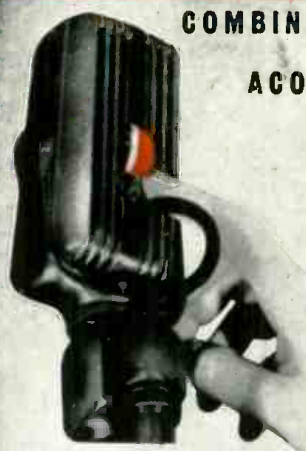
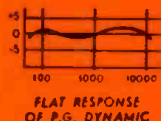

**COMBINATION VELOCITY-DYNAMIC
 ACHIEVED WITH
 ACOUSTIC COMPENSATOR**

An exclusive Amperite feature: By moving up the Acoustic Compensator you change the AMPERITE VELOCITY to a DYNAMIC microphone without peaks. At the same time you reduce the back pick-up, making the microphone practically UNI-DIRECTIONAL.

WITH ACOUSTIC COMPENSATOR:
 MODEL RBHk: RBMk (200 ohms) with switch, cable connector.

Chrome. LIST \$42.00

RSHk: RBSk (200 ohms). Switch, cable connector, Acoustic Compensator.

Chrome or Gunmetal. LIST \$32.00

WRITE FOR FREE SALES AIDS

AMPERITE KONTAK MIKE
 Puts Musical Instruments Across



So beautiful is the tone produced with the Kontak Mike, that it was used in the Philadelphia Symphony to amplify a mandolin solo. Gives excellent results with any amplifier, radio sets, and record players.

MODEL SKH (hi-imp) LIST \$12.00

MODEL KKH, with hand volume control.. LIST 18.00

Plug extra List 1.50

FOOT PEDAL, for making beautiful

crescendos LIST 12.00

AMPERITE ©. 561 BROADWAY, N. Y. U. S. A.

Specify **AMPERITE**



A FREE LESSON SHOWED BILL HOW HE COULD MAKE GOOD PAY IN RADIO

BILL, YOU'RE ALWAYS FOOLING WITH RADIO -- OUR SET WON'T WORK -- WILL YOU FIX IT?

I'LL TRY, MARY, I'LL TAKE IT HOME TONIGHT



I CAN'T FIND OUT WHAT'S WRONG -- GUESS I'LL MAKE A FOOL OF MYSELF WITH MARY

HELLO BILL -- GOT A TOUGH ONE TO FIX? LET ME HELP YOU

HELLO JOE -- WHERE'VE YOU BEEN LATELY -- AND WHERE DID YOU LEARN ANYTHING ABOUT RADIO?

I'VE BEEN STUDYING RADIO AT HOME, BILL, WITH THE NATIONAL RADIO INSTITUTE. YOU OUGHT TO TAKE THEIR COURSE. I'VE GOT A GOOD RADIO JOB NOW. LET'S MAKE A CIRCUIT DISTURBANCE TEST -- STARTING WITH THE AUDIO OUTPUT STAGE AND TESTING EVERY STAGE RIGHT BACK TO THE ANTENNA. LISTEN FOR THE CLICKS WHEN I TAP THE GRID LEADS

SAY -- WHERE DID YOU LEARN THAT TEST? IT'S A GOOD ONE



HERE'S THE TROUBLE, BILL, IN THE FIRST I.F. AMPLIFICATION STAGE. I LEARNED THAT TEST EVEN BEFORE I STARTED TAKING THE COURSE, BILL. IT'S DESCRIBED IN A FREE LESSON WHICH THE NATIONAL RADIO INSTITUTE SENDS YOU WHEN YOU MAIL A COUPON FROM ONE OF THEIR ADS

I'VE SEEN THEIR ADS BUT I NEVER THOUGHT I COULD LEARN RADIO AT HOME -- I'LL MAIL THEIR COUPON RIGHT AWAY

I'M CONVINCED NOW THAT THIS COURSE IS PRACTICAL AND COMPLETE. I'LL ENROLL NOW

AND THEN I CAN MAKE REAL MONEY FIXING RADIO SETS

OR INSTALL AND SERVICE LOUD SPEAKER SYSTEMS

OR GET A JOB WITH A RADIO BROADCASTING OR TRANSMITTING STATION

AVIATION RADIO, POLICE RADIO, TELEVISION, ELECTRONIC CONTROLS -- RADIO IS SURELY GOING PLACES. AND THE NATIONAL RADIO INSTITUTE HAS TRAINED HUNDREDS OF MEN FOR JOBS IN RADIO



I will send you a Lesson on Radio Servicing Tips FREE TO SHOW HOW PRACTICAL IT IS TO TRAIN AT HOME FOR GOOD JOBS IN RADIO



J. E. SMITH, President National Radio Institute Established 25 years

He has directed the training of more men for the Radio Industry than anyone else.

YOU CERTAINLY KNOW RADIO SOUNDS AS GOOD AS THE DAY I BOUGHT IT.

THANKS! IT'S CERTAINLY EASY TO LEARN RADIO THE N.R.I. WAY. I STARTED ONLY A FEW MONTHS AGO, AND I'M ALREADY MAKING GOOD MONEY.



THIS SPARE TIME WORK IS GREAT FUN AND PRETTY SOON I'LL BE READY FOR A FULL TIME JOB

Every man who works on a Radio Receiver, either professionally or as a hobby, should have a copy of my Free Sample Lesson, "Radio Receiver Troubles—Their Cause and Remedy." I will send you your copy without obligation if you will mail the Coupon below. It will show you how practical my lessons are—give you a real idea of the vast amount of information my Course gives you.

Why Many Radio Technicians I Train Make \$30, \$40, \$50 a Week

N.R.I. trained Radio Technicians hold good jobs in practically every branch of Radio, selling, servicing, installing, repairing, home and auto radio sets. N.R.I. trained Radio Operators have good jobs in Broadcasting, Commercial, Aviation, Police, Ship, Radio Stations. Many operate their own part or full-time Radio businesses, fixing, selling Radio sets. Others make good money in Public Address work and other branches of the Radio Industry.

My Course is thorough and practical. I give you basic training in Radio Theory and Engineering Practice which enables you to understand the operation and design of practically every type of Radio apparatus. You understand your work—know just what to do—instead of just relying on mechanical ability to fix a few common faults and make a few simple adjustments. That's why many

men who have been in Radio before enrolling report that my Course helped them make more money, win success. I train you too for Television, a promising field of future opportunity.



You Get This Professional Radio Servicing Instrument

as part of my Course to help you make more money, do better Radio work. For full details, mail the Coupon.

Beginners Quickly Learn to Earn \$5 to \$10 a Week Extra In Spare Time

Nearly every neighborhood offers opportunities for a good part-time Radio Technician to make extra money fixing Radio sets. I give you special training to show you how to start cashing in on these opportunities early. You get Radio parts and instructions for building test equipment, for conducting experiments that give you valuable, practical experience. My 50:50 method of training—half with Radio parts I send you, half studying my Lesson Texts—makes learning Radio at home interesting, fascinating, practical.

MAIL THE COUPON—get my Sample Lesson and 64-page Book "Rich Rewards in Radio" at once. They're free. See what Radio offers you as a skilled Radio Technician or Operator. Learn how practical my Course really is. Read letters from more than 100 men I have trained telling what they are doing, earning. Mail the Coupon NOW—in an envelope or paste it on a penny postal.

J. E. SMITH, President, Dept. INX National Radio Institute, Washington, D. C.



OH BILL -- I'M SO GLAD I ASKED YOU TO FIX OUR RADIO, IT GOT YOU STARTED THINKING ABOUT RADIO AS A CAREER, AND NOW YOU'RE GOING AHEAD SO FAST

OUR WORRIES ARE OVER. I HAVE A GOOD JOB NOW, AND THERE'S A BIG FUTURE AHEAD FOR US IN RADIO



EXTRA PAY IN ARMY, NAVY, TOO

Every man likely to go into military service, every soldier, sailor, marine, should mail the Coupon Now. Learning Radio means more money, extra rank, extra prestige, more interesting duty at pay up to 6 times a Private's base pay. Also prepares for good Radio jobs after service ends. IT'S SMART TO TRAIN FOR RADIO NOW!

J. E. Smith, President, Dept. INX, National Radio Institute, Washington, D. C.

Mail me FREE without obligation, Sample Lesson and 64-page book "Rich Rewards in Radio," which tells about Radio's opportunities and explains your 50-50 method of training men at home. (No salesman will call. Write plainly.)

Age.....

Name

Address

City State

14X1

RADIO-CRAFT

Incorporating

RADIO & TELEVISION

HUGO GERNSBACK
Editor-in-Chief

H. W. SECOR
Managing Editor

CARLOS FROWEIN
Art Director

IN THE NEXT ISSUE!

- "Sound" in National Defense Plants
- "Gyps" and "Tips" for Servicemen
- Building a Low-Cost P.A. System
- Servicing School Sound Systems
- New Volume Expander-Compressor
- Wien Bridge Audio Oscillator
- 2½ M. Walkie-Talkie Transceiver

Contents NOV.-DEC., 1941 Issue

VOLUME XIII -- NUMBER 5

Mailbag	260
Editorial: Special Announcement	Hugo Gernsback 263
The Radio Month in Review	264

RADIO DEFENSE

How Mobile Army Set Gave Enemy "Hot" Info	Glenn Garry 266
How NYA Trains Radio Men	268

SERVICING

Speedy Servicing	Harold Davis 270
RADIO SERVICE DATA SHEETS: No. 318 Pilot FM/AM Receiver	272
Interference Analysis	W. J. Zaun 276

SOUND

How New RCA Automatic Record-Changer Works	280
70-Watt Flexible Amplifier	282
How to Sell "School" Sound Systems	B. E. Philippsen 284
A High-Quality Amplifier	Emile J. Rome 292

ENGINEERING

Coil Coupling Problems	L. V. Sorensen 294
------------------------------	--------------------

ELECTRONICS

Experimental Photo-Cell Relay	L. M. Dezettel 298
-------------------------------------	--------------------

TEST INSTRUMENTS

Modernizing a Test Set	E. A. Graves 300
------------------------------	------------------

DEPARTMENTS, ETC.

Latest Radio Apparatus	303
------------------------------	-----

RADIO & TELEVISION

Compact Kilowatt Xmitter	Larry LeKashman 305
Reader's Editorials—Prize Set Award	307
Hi-Freq. Converter	Howard Burgess 308
Radio Kinks	310
A 3-Tube DX'er	L. M. Dezettel, W9SEW 312
Electrical Experiments	314
End-Fed Zepp for Receiving	R. H. Newkirk, W9BRD 316
"Honor Plaque" Award	318



Published by Radcraft Publications, Inc. Publication office: 29 Worthington Street, Springfield, Mass. Editorial and Advertising Offices: 25 West Broadway, New York City. Chicago Advertising Office: RADIO-CRAFT, 520 North Michigan Avenue, Chicago, Ill.

RADIO-CRAFT is published monthly, on the first of the month preceding that of date; subscription price is \$2.50 per year in U. S. (In foreign countries, 75c additional per year to cover postage; Canada, 50c additional.) Entered at the post office at Springfield as second-class matter under the act of March 3, 1879. All communications about subscriptions should be addressed to: Director of Circulation, 25 West Broadway, New York, N. Y.



Foreign Agents:

London—Gorrings American News Agency, 9A Green St., Leicester Square, W. C. 2, England.

Paris—Messageries Dawson, 4 Rue Faubourg, Poissonniere, France.

Melbourne—McGill's Agency, 179 Elizabeth St., Australia.

Dunedin—James Johnston, Ltd., New Zealand.



Text and illustrations of this magazine are copyright and must not be reproduced without permission of the copyright owners.



Copyright 1941 Radcraft Publications, Inc.



*There's Only One Way
to Learn Anything*

DO IT!



**SPRAYBERRY RADIO TRAINING
Gives You FULL EQUIPMENT to
Do Over 100 Practice-Giving Experiments!**

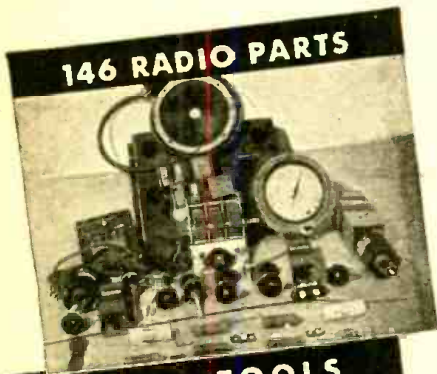

146 RADIO PARTS

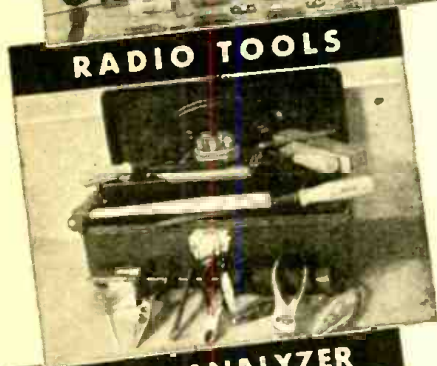

RADIO TOOLS

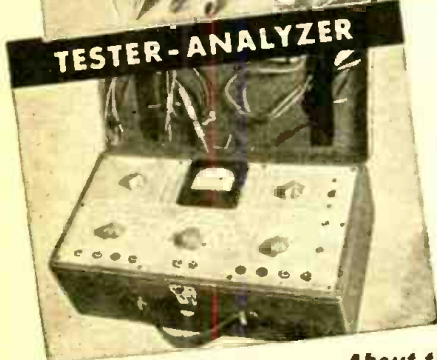

TESTER-ANALYZER

You Get PRE-EXPERIENCE Right At HOME!

Sprayberry Training is specially designed to help you make fast progress. It starts right at the beginning of Radio . . . unfolds each subject in a simplified, logical, understandable style. You easily learn Television, Frequency Modulation, Signal Tracing, Mobile Radio (Auto-Tank), Aviation Radio, Electronics, Facsimile Radio, Radio Set Repair and Installation Work. You learn quickly in your spare hours . . . AT HOME OR AT CAMP.

**Training Prepares You for a Business of Your Own
. . . or Good Radio Jobs at Excellent Pay!**

The great, fascinating and progressive field of Radio and Television offers limitless opportunities to the man who wants to get ahead. There is good money to be made. My Training is designed to give you quick access to these opportunities. SPRAYBERRY Methods are thorough and practical. Your Training will not interfere with your present work.

**YOU GET PROFESSIONAL TEST EQUIPMENT
. . . PLUS EXPERIMENTAL OUTFITS**

. . . Includes 146 RADIO PARTS for building a complete Receiver, RADIO TOOLS and a modern TESTER-ANALYZER. You also receive 8 BIG SHIPMENTS OF RADIO EQUIPMENT for conducting actual experiments with your own hands. I show you how to create Radio defects . . . how to correct them. ALL EQUIPMENT BECOMES YOUR PERSONAL PROPERTY!

NO PREVIOUS EXPERIENCE NEEDED . . . EARN WHILE YOU LEARN

It makes no difference what your education has been. I can fit you quickly for a good-paying Radio Job. I make it easy for you to grasp Radio principles and remember them. Your success is my full responsibility. My BUSINESS BUILDERS will show you how to put your Equipment to actual use in handling money-making Radio Service Jobs shortly after you begin Training.

**REMEMBER— THE SPRAYBERRY COURSE IS SOLD
UNDER MONEY-BACK AGREEMENT**

LEARN MORE ABOUT THE SPRAYBERRY METHOD . . . complete details of my Fundamental Course and Advanced Training Course—all features are fully described in my new, valuable 52-page FREE Book. Send for your copy. No obligation.

**READ What These Fellows Say
About the Practical Sprayberry Training!**

"GROSSED BETWEEN \$150 AND \$200"



"Since finishing your training I've started in the Radio repair business. I have about all the work I can take care of. I have grossed between \$150 and \$200 in the last few months in my spare time. I think your Course is 'tops'." W. Francis Waseka, Fountain City, Wisconsin.

"SALARY HAS INCREASED"



"Your Radio training has made it possible for me to make more money. My salary has increased from \$40.00 to around \$50.00 per week. I now have about all the Radio repair work I can handle." Asa Smith, P. O. Box 528, Fort Leavenworth, Ky.

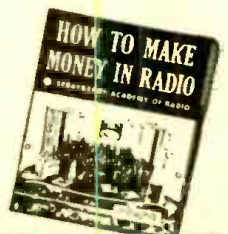

RUSH THIS COUPON for BIG FREE BOOK

SPRAYBERRY ACADEMY OF RADIO
F. L. Sprayberry, Pres.
420-M University Place, N. W.
Washington, D. C.

Please send me FREE copy of "HOW TO MAKE MONEY IN RADIO."

Name Age

Address

City State

Tear off this coupon, mail in envelope or paste on penny postcard.

"MAN TO MANTALK-- TO THE RECENT HIGH SCHOOL 'GRAD' "

The young fellow just out of High School finds himself in a unique position today. Employers, for the past six months, have been asking for YOUNG radio technicians—fellows of High School age. Normal expansion in the radio industry, coupled to the needs of the national emergency, have created a serious shortage of radio men. The *young fellow* is being sought by the radio industry!

The High School graduate today is faced with the tempting prospect of high wages in factory and shop; plans of higher education may take a back seat for the immediate attraction of

more "spending money." Such employment cannot lead to desirable permanent positions, however, and the young man who does desire something better would do well at this time to pass by such transitory work.

For those considering Commercial Radio as a career, we urge a careful study of the courses offered at the Dodge Institute. Compare them with any other offered anywhere. Contact our graduates for their opinion; or, best of all, visit our school. We invite comparison!

Next class organized Jan. 5. A postal card brings our catalog.

DODGE'S TELEGRAPH & RADIO INSTITUTE
704 MONROE ST. VALPARAISO, IND.

replacing of tubes that were not needed. Now, who said they were *not* needed? Anyone who has experience in radio servicing will testify that a majority of their work in recent months is on *new* sets. And a majority of new set work is on those of the type used by *Readers' Digest* investigators. And, still a majority of the defects found in these "tin-can" portables are tubes. (I defy *Readers' Digest* to make this survey and get any other result, even in their own biased way.)

Walter Jones of Hygrade Sylvania (tube manufacturers) spent years traveling around the country telling radio servicemen how sorry tube-checkers are. Yet, this is the only way a radio man has of telling the condition of tubes. Your magazine, along with all others, carries page after page of advertising telling the merits of *tube-checkers*. When a serviceman puts a tube in a nationally advertised tube-checker (even Superior) and it tells him that tube is bad in plain everyday English, he has a clear conscience to sell his customer a new tube. And when anybody's portable with hair-line filament tubes is used for any length of time and the tubes still read into the green, it is a miracle!

The condition is even worse than that. There are few times when any two tube-checkers will check the *same* tube with the *same* results. The conglomeration of tubes on the market make it impossible for the manufacturers to make a decent tube-checker that will be portable, or within the buying power of the serviceman.

Which all boils down to this: Is the serviceman dishonest who sells his customer a new tube when his instruments tell him that the customer needs one? Emphatically no! No more so than the doctor who X-rayed my wife and put her to bed on a wrong type of diet and caused her condition to grow worse.

Another charge was taking out good tubes and installing inferior ones. Who said they were inferior? What is an inferior tube? Surely the serviceman is in a better position than anyone else to say what make tube gives him the best service, and the one that does this is the *best* tube to him, regardless of whose name it has on it. I have never yet seen a serviceman continue to use parts that did not hold up and give the proper service. There simply isn't enough difference in the price to justify the trouble caused by them.

And, now we come to the point of the serviceman telling the customer that he did *this and that* to the set. It makes no difference what a radioman tells his customer what is wrong with the set—it all sounds alike to him. As a result, a majority of servicemen tell them the first thing they think of, in as flowery terms as possible and think no more of it. This is not meant to deceive, it is simply a trick of the trade. If servicemen spent the time required to explain the exact trouble in each set, he would have little time for anything else and would be wasting a lot of time. When he has finished, the customer knows exactly as much as before he started. Many servicemen have hunted hours for a cold solder joint that came out of the factory, and then explained it to the customer as a bad condenser. If he were to even attempt to charge the customer \$5.00 for spending three hours running down a cold joint, the customer would want to have him arrested! Yet, he has to charge for such work, and *he is justly entitled to pay for it.*

The little "white lies" the serviceman is forced to tell his customer in such instances is not dishonest. He could probably avoid them by simply stating what he did to the set was his business, but he could hardly keep his customers.

ARE SERVICEMEN GYPS?

The Editorial in our September issue entitled, "64% of the Radio Servicemen Are Gyps," caused no end of comment, pro and con. Of the hundreds of letters received we have chosen one which we give you below. It will be noted that not even Servicemen themselves are agreed on the controversy.—EDITOR

IS THE SERVICEMAN DISHONEST?

Dear Editor:

I was completely dumbfounded to read Mr. Gernsback's September editorial. To think that a man of his experience and intelligence would be duped into turning against the people who keep him in business, and flash across the face of the earth such an unwarranted charge as set forth in this editorial. It simply points out what this writer has long contended—people who publish radio magazines know nothing about the radio business.

If *Readers' Digest* or any other person or company says 64% of the radio servicemen are gyps, they are liars! And anyone who would use the pages of supposedly unbiased publications to defame the character of an industry in any such way, is no better than the Fifth Columnists this country is busy fighting.

Readers' Digest has gone through the industries one by one and has shown that *everybody is a crook!* It published the same thing on the automotive industry. Their investigations are set up to give them the results they want. They are unfair, unscrupulous, and they are everything but unbiased. Their objective is to show up the people they investigated, and this is exactly what they do. It is an easy matter to find fault, and it is still easier to twist words and circumstances to suit the writer or speaker. That is why celebrities are compelled to shun "news" people. Their most simple remarks are often distorted until they are not even recognizable.

Taking up the complaints of *Readers' Digest* one by one, let's see the other side of the story. (Remember, we have only heard one side.) One of the chief complaints was



**QUICK, EASY WAY
TO TRAIN FOR
RADIO
in 8 WEEKS**

H. C. Lewis

I'LL FINANCE YOUR TRAINING
Mail the Coupon TODAY and I'll not only tell you about my quick, easy way to train for a good pay job in Radio, Television and Sound, BUT, I'll also tell you how you can get it and pay for it, in Easy monthly payments starting 60 days after 8 weeks' training period.

LEARN BY DOING
On Real Equipment in Coyne Shops
Simple, easy method of Practical Training. You don't need previous experience or a lot of book learning. You work on real equipment in the Coyne Shops at Chicago. This 8 weeks training prepares you for a job in service and repair work—we also offer radio operating training. Full details of this training will so be sent you when you send coupon.

**EARN WHILE LEARNING,
Job Help After Graduation**
We help you get part time work to help with living expenses, and then give you employment service after graduation.

H. C. LEWIS, President,
Radio Division, Coyne Electrical School,
500 S. Paulina St., Dept. 91-8H, Chicago, Ill.
Dear Mr. Lewis:
Please send me your Big FREE Book, and details of your PAY-AFTER-GRADUATION-PLAN.

NAME.....
ADDRESS.....
CITY..... STATE.....

**SEND
COUPON
TODAY**

RADIO TECHNOLOGY

RCA Institutes offer an intensive course of high standard embracing all phases of Radio and Television. Practical training with modern equipment at New York and Chicago schools. Also specialized courses in Aviation Communications, Radio Servicing and Commercial Operating. For Free Catalog Write Dept. BC-41.

RCA INSTITUTES, Inc.

A Radio Corporation of America Service
75 Varick St., New York, 1154 Merchandise Mart, Chicago

RADIO-TELEVISION

Oldest, largest Radio-Television school in West trains you for good pay job. Complete instruction including Radio Construction and Service, Broadcast Operating, Sound-Talking Pictures, Television, Public Address, etc. Flexible plan to meet specific needs of those with or without jobs. Transportation allowed to L.A. Earn room and board while learning. Request Free Catalog.

NATIONAL SCHOOLS

Dept. 12-RC
Los Angeles

EASY TO LEARN CODE

It is easy to learn or increase speed with an Instructograph Code Teacher. Affords the quickest and most practical method yet developed. Available tapes from beginner's alphabet to typical messages on all subjects. Speed range up to 40 WPM. Always ready—no QRM.

MACHINES FOR RENT OR SALE

The Instructograph Code Teacher literally takes the place of an operator-instructor and enables anyone to learn and master code without further assistance. Thousands have used and endorse the Instructograph System. Write today for full particulars and convenient payment and rental plans.



INSTRUCTOGRAPH COMPANY

4713 Sheridan Rd., Chicago, Illinois
Representatives for Canada

Radio College of Canada, 54 Bloor St. West, Toronto.

LEARN RADIO TELEVISION

500 LICENSED graduates placed in past 7 years in shipping, broadcasting, aviation, police, etc.; we also teach radio servicing and repairing; new beginners' class now forming; 60-page catalog free; oldest, largest and best equipped.

MASS. RADIO SCHOOL

18 BOYLSTON ST., BOSTON, Mass., Est. 1899

AMATEUR RADIO LICENSES

Study for your licenses the "rhythm" way, the A.R.I. way. Acquire code proficiency in from 3½ to 8 weeks. Theory taught in understandable, non technical language. Classroom courses in New York, home study courses for outside students. Write for list of calls of hundreds of licensed students now on the air.

AMERICAN RADIO INSTITUTE
1123 BROADWAY, NEW YORK, N. Y.

RADIO-TELEVISION STATION OPERATOR COURSE

This New Course shows how to get a License to Operate Television, Facsimile, Radiotelephone and Broadcasting Stations. Latest, Inexpensive, Short-Cut Course by A. Binneves, Jr., B. Sc. Includes 150-page Book with Diagrams, Answers 700 Actual Questions! We answer any other Questions by Mail. NO CODE NECESSARY! Send \$4.00 Now for Self-Study Book and Complete Study Course. No More to Pay!

RADIO-TELIO INSTITUTE

524 Fairbanks Ave., Oakland, California

Be a RADIO SERVICE EXPERT LEARN AT HOME IN SPARE TIME

The demand for radio experts grows every day. Learn this paying profession under personal guidance of qualified engineer and educator. Clear, fascinating instruction and experimental kits make learning easy. Leaders in the radio industry endorse R.T.A. methods. Spare time profits soon pay for training.

FREE book telling what R.T.A. training can do for you. **RADIO TRAINING ASS'N. OF AMERICA**
1559 Devon Ave. Dept. RC-121 Chicago, Ill.

COMMERCIAL RADIO INSTITUTE

A radio training center for over twenty years. Well equipped. Excellent faculty. Practical resident courses in Radio Telegraphy, Broadcast, Servicing, Industrial, Television, Aeronautical, Drafting, Mathematics and Studio Technique. Placement bureau. Classes now forming for mid-year term Feb. 9th. Catalog upon request.

Dept. D, 38 West Biddle Street, Baltimore, Md.

Correspondence Courses in RADIO and ELECTRICAL ENGINEERING

ELECTRICAL ENGINEERING Get good grasp of wide electrical field. Prepare yourself, at Low Cost, for secure future. Modern, simplified, you can understand quickly.
RADIO ENGINEERING Extra fine course in radio, publishes address, photo-electric work. Trains you to be super-service man, vacuum tube technician. Exper. kits furnished. Diploma on completion. Tuition, \$25 either course. Deferred payment plan.
FREE Get copies of school catalogs, student magazines, complete details. SEND NOW!

LINCOLN ENGINEERING SCHOOL Box 931-C95, LINCOLN, NEBR

USED Correspondence Courses

page bargain catalog FREE. Write today!
NELSON COMPANY, 500 Sherman, Dept. L-210, Chicago

Another reason why a serviceman has to tell his customers little white lies, is because he cannot tell them, as doctors do, that any time they bring work into his shop, they must pay—regardless of results. A serviceman can spend 30 minutes checking tubes for a customer and only get "thank you." He cannot live on that, and he is compelled in self-defense to offset on one customer what he loses on another. This is common business practice in every industry. A contractor, for instance, will lose money on one job and make it up on another. Merchants lose money on articles they call "leaders," but make it up on other sales. Firms operate branch offices at a loss to fight competition, but make enough on others to offset it. Now, why in the name of common sense is it dishonest for servicemen to follow an accepted practice in business? If the contractor and merchant told their customers that they had lost money in a previous transaction, and were going to make it up on the customer, how much business would they do? A little far-fetched, perhaps, but it is logical.

A radio owner is not gypped or cheated so long as he comes in with a dead radio and goes out with it playing! The serviceman performed some professional service, got results and is entitled to pay, and beddamned with *Readers' Digest* or anyone else who says differently.

There is one simple fact that will prove that 64% of the servicemen are not gyps. There never was a racket that didn't make money. If radio servicing is a racket, radio servicemen should be making money. They are not! I have never heard of anyone in the radio service business making any real money. Few even make a decent living without supplemental sales of radios or other merchandise. I have never heard of a serviceman drawing over \$50.00 per week salary. Few in business for themselves achieve this much. No, radio service is not a racket. If it was, there would be more money in it.

Radio service is one of the most difficult of trades. It can be compared more closely to the medical doctor's work than any other. Everything that a radio serviceman does is based on experience or interpretation of instruments. There are few instances where a serviceman can look at a part and tell if it is good or bad. He must interpret this from a meter. A condenser may be bad one instant and good the next. A tube checks good in a tube-checker and refuses to play! One checks bad and plays perfectly. An I-F absorbs moisture and refuses to pass a signal, yet checks perfectly on all routine tests. A set quits playing for no reason at all, and starts back just as readily. You can cut out many of the parts without impairing its performance. It plays bad in the home and good in the shop. It is the most sentimental conglomeration ever concocted by man.

I do not wish to make believe that I do not know there are some dishonest servicemen. Of course there are. There are dishonest every kind of men—doctors, lawyers, politicians (with capital "P"), mechanics, and so on. But 64% of the radio servicemen are not dishonest! They are simply the most under-paid, under-rated, least understood and least helped people of all the trades.

Sincerely,

HAROLD DAVIS,
Jackson, Mississippi.

DON'T MISS 'EM!!
More Vital and Interesting Letters from Servicemen in Next Issue!

RADIO TRAINING



Founded in 1909

PORT ARTHUR COLLEGE, a non-profit making educational institution, offers a practical radio operator's course at the lowest tuition price in its history. Each radio graduate receives two months' actual operating experience at the college's commercial broadcasting station KPAC. This station is equipped with the latest type 1000 watt high fidelity RCA transmitter—1250 kc.—directional antenna system. KPAC operates in new modern studios located on the campus.

The college has never advertised jobs or positions in lieu of education. Today it is well known there is a shortage of radio operators in every branch of radio; therefore, we believe it is good common sense to mention that Port Arthur College is the sole radio school in America which owns a commercial broadcasting station with commercial advertising representatives in New York, Chicago, San Francisco, and many of America's leading cities, with active membership in the National Association of Broadcasters, and Broadcast Music Incorporated. Through these contacts the college receives from the broadcast industry alone a great many more calls for student radio operators than it is possible to supply.

Authorized to teach RCA texts.

If interested, write for Bulletin R-51

PORT ARTHUR COLLEGE
PORT ARTHUR (World-Known Port)
TEXAS



CHECK HERE!

..... if you want a **BETTER** radio job!

Technical ability is the only thing that stands between you and a better job. . . . **CREI** can prepare you **NOW** with just the training you need!

Yes, YOUR opportunity is here. NOW! Our home study courses are "made to order" for this opportunity. CREI trained men are in demand throughout the radio industry . . . and the demand will increase as the months go by. If the lack of technical training is your stumbling block . . . you can do something about it now—if you will. Your radio experience backed by CREI modern training will equip you to share in the better, good-paying jobs that await trained men. 5000 radiomen can't be wrong!

WRITE FOR FACTS TODAY! Our **FREE BOOKLET** and personal recommendations may hold the answer to your future success. Write today and please state briefly your background, education and present position.



CAPITOL RADIO ENGINEERING INSTITUTE

Dept. RC-12, 3224 16th St., N. W., Wash., D. C.

RADIO COURSES

- Start January
- RADIO OPERATING—BROADCASTING
- RADIO SERVICING—a practical course
- RADIO AMATEUR CODE • TELEVISION
- ELECTRONICS—1 yr. day course 2 yrs. eve. Day and Evening Classes. Booklets Upon Request.

New York Y.M.C.A. Schools
4 W. 64th Street New York City

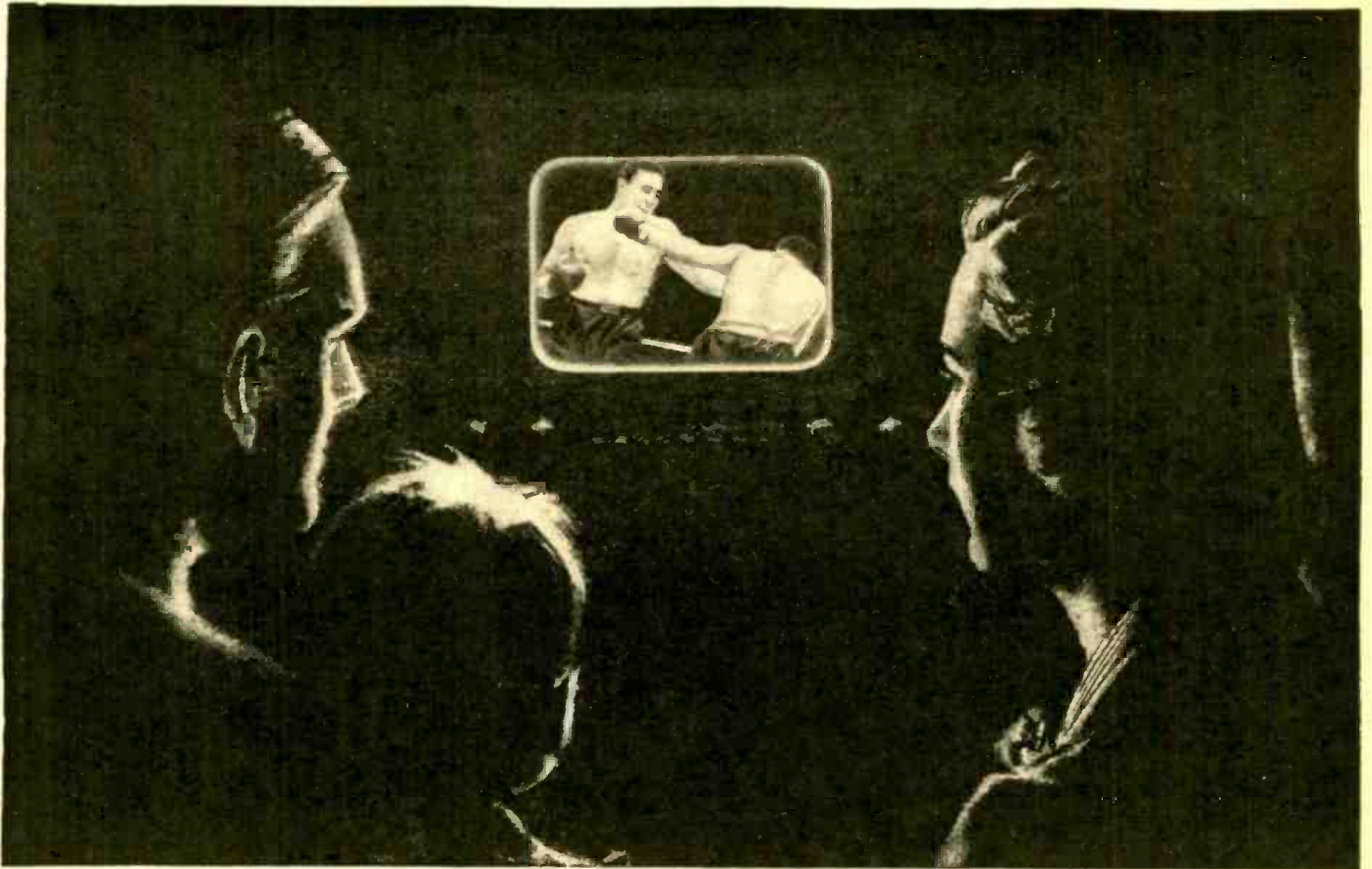

Thanks to Radio Research

Thousands now Look as they Listen!

On the New York air, these nights at 8:30 o'clock, it's television curtain time. It is estimated that 5,000 television receivers—all front-row seats—are lined up, mostly in homes and public places, to see the shows—the matinees and evening performances—15 hours of entertainment a week from the NBC studio stage and from fields of sport.

Study of statistics gathered by the NBC pioneer television station WNBT, which began commercial programs July 1, reveals that the video audience in the Metropolitan area already numbers about 18,000 in the afternoon and 30,000 in the

evening. On the average, more than 55% of the sets are turned on in the daytime and 80% at night. Seeing by radio is as simple as listening, as far as the receiver manipulation is concerned.

The programs range from fashion shows to prize fights, from spelling bees to a Wild West rodeo, from baseball to travelogues, and from football to illustrated news; while songsters, dancers, magicians, dramatists and bands add to the variety. That people can sit sixty miles away and look in on Madison Square Garden to watch the rodeo. To see a bucking bronco throw its cowboy

rider across the wavelengths is one of the wonders of this age.

Electronic research in RCA Laboratories has put the television shows into space. Electronics—that science which makes miraculous use of infinitesimal bits of electricity—is continuing radio's advance across the threshold of the "Television Age."

The main gateway through which television has emerged to become a service to the public is RCA Laboratories. It is from this magic realm that new wonders in radio sightseeing will come to give this and future generations new and dramatic visions.



RCA LABORATORIES

A Service of the Radio Corporation of America, Radio City, New York.

Other RCA Services: RCA Manufacturing Co., Inc. • Radiomarine Corporation of America • RCA Institutes, Inc. National Broadcasting Company, Inc. • R.C.A. Communications, Inc.

RADIO-CRAFT

Incorporating

RADIO & TELEVISION

"RADIO'S GREATEST MAGAZINE"

Announcing . . .

RADIO - CRAFT

Incorporating

RADIO & TELEVISION

By the Publisher—HUGO GERNSBACK

RADIO-CRAFT (established 1929) and RADIO & TELEVISION (established 1930) are merged into a single magazine beginning with this issue.

So that our readers may understand why this important step was undertaken, let us state here what prompted this far-reaching decision.

It is no longer news that the entire world is in a turmoil at present and that the United States is marching forward with giant strides in its re-armament program.

It has become apparent for some time past that non-essential industries, in order to conserve resources, must of necessity cooperate with the National Defense Program. Inasmuch as the two magazines, RADIO-CRAFT and RADIO & TELEVISION, were published by the same management, it was felt that for the duration of the present emergency, it would be best to publish one magazine instead of two.

From an economic standpoint, there was also to be considered a constantly shrinking market while the emergency lasted. Many radio manufacturers who formerly patronized both magazines as well as other radio magazines, were forced to withdraw their advertising or curtail it severely, on account of priorities.

Many concerns were thus affected, and others will be severely affected as time goes on. For these reasons it became economically unsound to continue publishing two magazines at a loss, whereas it is possible to publish one magazine without a severe loss to its publishers.

While a few large radio manufacturers,—who have defense orders on hand,—continue to advertise, many of the smaller firms have not been able to do so; and being unable to obtain substitutes for the materials they need in their business, had to go into other endeavors, or cease operation altogether.

There was also a further reason which prompted our move, namely a realistic viewpoint of Television as it is today. RADIO & TELEVISION magazine for many years pioneered in television, but when it became increasingly clear that as long as the present emergency lasts, television would remain at a virtual stand-still, there was, of course, no further necessity to devote a large part of an expensive magazine to the subject.

While it is true that the Federal Communications Commission "has given the green light" to the television industry, making it possible for television broadcasting to accept commercial advertising now, it is also unfortunately true that all manufacturers have practically ceased building television equipment for the duration, due to lack of materials. Under such circumstances, it is clear that a magazine largely devoted to television becomes pointless at the present time.

On the other hand, RADIO & TELEVISION devoted the balance of its space to Amateur Radio. While American amateur radio has not been drastically affected up to now, the amateur radio industry is also face to face with a difficult materials problem on account of Defense priorities. And while radio amateurism has practically stopped completely in most of the countries of the world, it is still bravely carrying on in the United States, in spite of serious handicaps; and as long as this country is not officially at war, the radio amateur will not be suppressed. Most of the sector devoted to radio amateurism that appeared in RADIO & TELEVISION regularly, will continue intact in RADIO-CRAFT, beginning with this issue.

It should be understood by our readers that the consolidation of the two magazines is not to be considered as a final step. When the World War is at an end, when business returns once more to a peacetime basis, when television is freed from its war-time shackles, and when radio amateurs all over the world are free once more to communicate with each other, RADIO & TELEVISION will be published as a separate magazine again.

In the meanwhile, RADIO-CRAFT will continue its regular policy of publishing the same type of articles which it always published, PLUS a Radio Amateur and Ham section. And whatever advances are made in television will also be recorded in RADIO-CRAFT, as before.

For the remainder of the present emergency, we promise to keep RADIO-CRAFT the same important magazine it always was and, indeed, we hope to better it from month to month.

The publishers would be happy to receive your letters commenting upon the present merger of the two magazines.

• THE RADIO MONTH IN REVIEW •

The "radio news" paper for busy radio men. An illustrated digest of the important happenings of the month in every branch of the radio field.



HE WAITS FOR LIGHTNING TO HIT

Oddest job in all New York City is that of Ingolf Berger Johnson, young General Electric engineer. He had the assignment of making pictures of lightning striking the Empire State Building. Oscillograph equipment in the Empire State Building recorded the strength of the strokes and a remotely controlled camera on the roof of the Printing Crafts Building, several blocks distant, snapped pictures of the bolts at right-angles to those made from Fifth Avenue. These enabled scientists to make three-dimensional models of bolts. Photo data: Aug. 11, 1937, 9:52 P.M., MSB-46, Lens openings, still F.15, ROT. F.8, SS Pan film. Multiple stroke consisting of long-continuing low-current discharge followed by 6 noncontinuing discharges. Arrow indicates point at which the oscillograph started to record.

ZWORYKIN GETS AWARD

Presentation of the Rumford Award by the American Academy of Arts and Sciences on October 8, to Dr. Vladimir K. Zworykin, Associate Director of RCA Laboratories, brings honor to one of America's outstanding scientists in the field of radio, television and electronics.

The award specifically recognizes Dr. Zworykin's research work in development of the Electron Microscope.

Using electrons—infinitesimal bits of electricity—instead of light rays, and magnetic or electrostatic fields instead of glass lenses, the electron microscope enables man's eyes to see deeply into the sub-microscopic world. The electronic super-eye of this microscope sees far beyond the range of light waves. Magnifications up to 100,000 diameters are obtainable, making the in-

strument from 50 to 100 times more powerful than the strongest optical microscope.

Dr. Zworykin has won international renown for his invention of the Iconoscope, the "eye" of television, and the Kinescope, the screen-tube used in television receiving sets. It was these developments that gave television electrical scanning, simplifying and freeing the art from the limitations of mechanical scanning, which necessitated motors and whirling disks. In addition, Dr. Zworykin has made numerous contributions in the field of photo-electric cells and the electron multiplier. His inventions are appropriately described as projecting electronic beams far into the future to give new vision to generations to come, for his inventions are the foundation upon which television and other devices for harnessing electrons to useful purposes, are built.

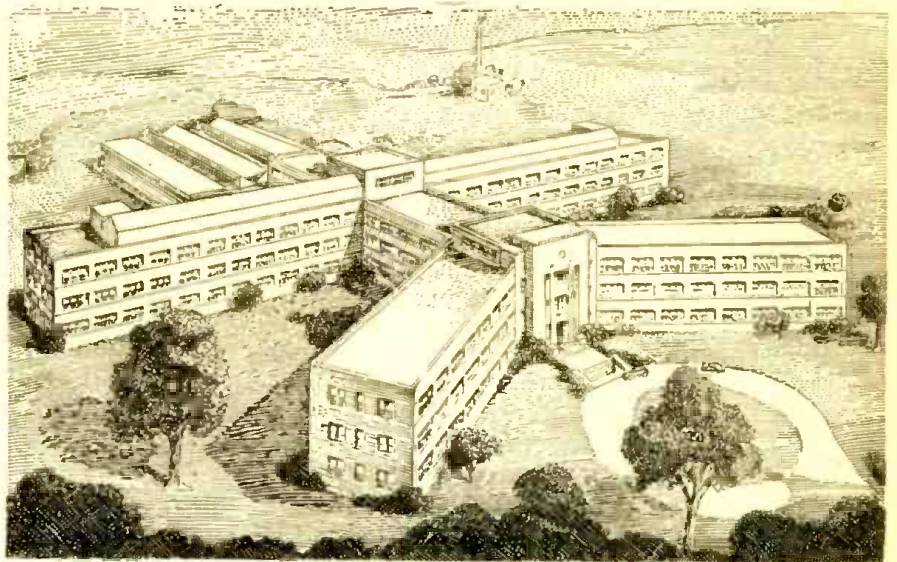

GROUND BROKEN FOR RCA LABORATORIES AT PRINCETON

Ground was broken recently at Princeton, New Jersey, for the Research Laboratories of the Radio Corporation of America. When completed, the buildings to be erected on a site of more than 250 acres will constitute the world's outstanding center for radio and electronic research. The most immediate requirement of the new RCA Laboratories will be to increase the usefulness of radio to national defense. It is expected that the main building will be completed and occupied by the RCA research organization early next spring.



CAMP WHEELER, GEORGIA, BROADCASTS TO THE HOME FOLKS!

Private Thomas F. Hanlon of the Public Relations Office monitors a transcription on his Presto Model Y recorder at Camp Wheeler, Georgia. He uses glass-base record blanks and runs them on a lateral pickup at 33 1/3 r.p.m. In the picture he is using an auxiliary mixer and a Gates amplifier in conjunction with his own equipment. The cutting head used is a 1-C Presto. His microphone is an RCA 88-A pressure type.

New Singapore Radio Station

The British Government has completed a large, modern and thoroughly equipped broadcasting station in Singapore that will serve both to combat the propaganda of the Axis powers and to spread that of Britain in the Far East.

The station, built by the Malayan Broadcasting Corporation, will be operated along the same lines as modern British and American stations, with speeches, dramas and musical programs.

Courtesy of the New York Times.

STATION TO SERVE FAR EAST

A new international broadcast station to serve the Far East has been initiated through the cooperation of various broadcasters, the Defense Communications Board, the Coordinator of Information, and the Federal Communications Commission.

The latter has authorized The Associated Broadcasters, Inc., licensee of standard broadcast station KSFO at San Francisco, to construct an international station there to broadcast to the Orient and Australia. For 16 to 20 hours a day news and entertainment will be sent in English, French, Dutch, Spanish, Portuguese, Japanese, and possibly, Chinese, Thai, Russian and Korean. Frequencies of 6060, 9570, 11,870, 15,350, 17,760 and 21,610 kilocycles will be used. In some instances this will mean sharing time with other domestic international broadcast stations.

Though about a dozen international broadcast stations now operate in the United States, only one—KGEI, licensed to General Electric—is on the West Coast (near Belmont, Calif.). The other stations, being located in the eastern part of the country, cannot serve the Orient. The Defense Communications Board urged additional facilities, and the Coordinator of Information has arranged for delivery of a 100-kilowatt transmitter from the General Electric Company to speed this new service.



FIRST TELEVISION FASHION SHOW

The first regular series of "commercial" television programs made its debut over WNBT in September, with a fashion show telecast from the NBC Television studios in Radio City, New York. The programs, sponsored by Bloomingdale's and Abraham and Straus' department stores. The first program, "Five O'Clock Party," a complete play with music, worked out a combination entertainment-plus-fashion-show type of presentation, centered around the leading lady's birthday. Tags and credit cards were flashed on the screen and occasional fashion commentary gave prices and described colors and details of the costumes. (NBC Photo.)

RCA LABS. FIND REPLACEMENT MATERIALS

As a result of the research necessitated by national defense for alternate materials in radio sets, RCA Laboratories has developed more than forty replacement materials. One item alone has saved 148,000 pounds of aluminum in the plants of the RCA Manufacturing Company.

Twenty of the newly developed materials are being used in RCA's radio production, as the result of its broad, long-term program of conservation. A dozen more alternates have been approved and scheduled for early use; many others are available for production as necessity arises, while the process of development continues promising additional alternates.

In every RCA Victor radio set, an aluminum can was employed to protect intermediate transformer coils. Four millions of these cans had been used in 1940; therefore, if they could be replaced by using an alternate, a tremendous saving in aluminum would result.

The engineering department suggested that a fabricated cardboard tube, coated with a moisture-resisting substance and a sheet of copper foil, be used instead of the aluminum can. This was done with marked success. The aluminum saved has amounted to seventy-four tons. Another important saving of aluminum by RCA was effected by using a plastic in the record changer control segment of radio phonographs.

Plastics are under consideration to replace the metal housing that protects loudspeaker cones in radio receivers. They can also be used in making dial faces and a number of other parts in both radio and phonograph equipment. Their possible field of application is extremely wide. But even plastics are likely to meet curtailment, because defense needs have created a shortage in the supply of formaldehyde, required to manufacture the synthetic resin used as a base in some plastics.

Thereupon, the job of finding an alternate for an alternate was started. The answer was a felted substance made from shredded wood, cardboard paper scraps, and sulphite pulp. Moulded into required forms and treated with a moisture-resisting

impregnant, it proved to be as tough as either wood or plastic. It can be covered with fabricoid or other surfacing. By the use of thermofusion, metals can be bonded to it.

Experiments also are being conducted with Lignin, a by-product of paper mills, as a proxy for plastics. Treated with a felting process, it provides a workable, hard, durable and lasting material.

In another instance, RCA chemists have found a replacement for the phenol-formaldehyde resins used in radio manufacture to impregnate paper tubes upon which wire coils are wound.



PORTABLE BROADCAST UNIT

Faced with the problem of broadcasting recordings from Manhattan Beach (New York) station, WMCA engineers designed and built a portable unit which weighs less than 100 pounds and which can be transported for any similar job. The equipment, constructed according to specifications by Frank Marx, WMCA chief engineer, is pictured in use at Manhattan Beach in the photo. Picture number one shows the turntables with the top of the waterproof carrying case removed for the program. They are heavy duty constant speed motors, adjusted for either 33 and 1/3 or 78 R.P.M. The amplifier and mixer is packed in a special case; this unit has a three-position mixer, giving control over either of the turntables and the microphone or all three simultaneously. The amplifier is high gain and feeds the program over special radio telephone lines to the master control in the WMCA studios. In this broadcast, the program is also fed to more than 100 loudspeakers situated throughout the Beach.



MESSERSCHMITT RADIO

William P. Lear, designer and builder of aircraft radio for U.S. and Allied Air services, tests the Messerschmitt 109 radio apparatus at Lear Avia's engineering laboratories at Piqua, Ohio. Mr. Lear's investigation disclosed that:

- (1) The Germans have apparently "frozen" their military radio design since 1933, and standardized their tubes and components for ease of mass production servicing.
- (2) Shortages of war materials are indicated by the use of ceramics instead of plastics, fibre instead of rubber and special alloys instead of aluminum.
- (3) The extremely limited range of the transmitter (around 5 miles), and the provision for higher power output, indicate that most German warplanes in a given squadron can talk only to one another, while the leader only can talk to his base.
- (4) German aircraft radio apparatus found in the Messerschmitt cannot pass U.S. Government test for even commercial radio equipment and weighs more than comparable American apparatus. (Lear Avia Photo.)

At the rate of twenty a week, upwards of 300 radio transmitters, designed for ground-to-plane communication, are rolling off the assembly lines at Western Electric's Kearny, N. J., works for delivery to Pan-American Airways, Inc. These transmitters will form a vital part in Pan-American's far-flung communications system which links the flying Clippers to terminals in the U. S., Alaska, and other distant lands.



24-HOUR LISTENING POST

America's most sensitive ear to Europe's violent war of words was formally opened recently in the presence of 150 newspaper and radio men. Twenty-four foreign language experts and engineers "cruise" the world's radio waves throughout the day's twenty-four hours for news at the Bellmore, Long Island, location, forty miles from New York City. The post, at which Rome, Moscow, Berlin and London are heard as clearly as a "local" station, occupies the most favorable site on the Atlantic seaboard, according to Jules Van Item, NBC chief of the listening post. Foreign news broadcasts, addresses by military and political leaders and official communiques are recorded by electrically operated devices for translation. The news is relayed to NBC's Radio City headquarters by teletypewriter circuit. (NBC Photo.)

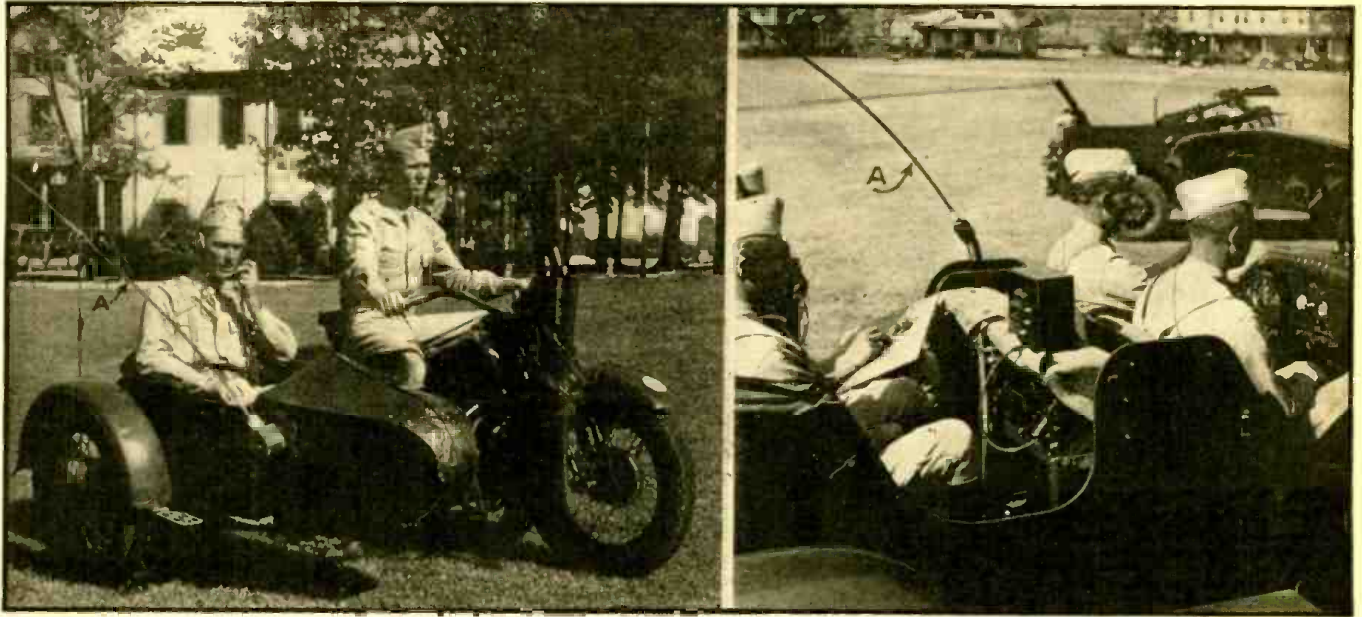

Left—Note antenna at "A" on motorcycle 2-way set. Right—Antenna at "A" on mobile set in Scout Car. Photos courtesy U. S. Army Signal Corps.

How Mobile Army Set

GAVE ENEMY "HOT" INFO

This article written by an army officer, relates the story of an actual interception of important military information by an "enemy" radio station within the lines! It actually happened during U. S. Army maneuvers and demonstrated the importance of radio in modern warfare.

GLENN GARRY

AT four o'clock in the morning I was leading the forward elements of the Regimental Command Post into position. The Enemy were known to infest the far bank of the river just 1000 yards to our front. Our immediate mission was, of course, to get into the new position without being detected. As there was no moon, and all vehicles were moving without lights, the entire movement was shrouded by darkness—that depth of darkness that can be provided only by a bleak, cold, rainy winter night.

Following close behind me as I ran stumbling through the mud, was a column of vehicles consisting of two medium tanks and four armored scout cars, all destined to play their part in a determined attack on the Qth Hostile Infantry. Not having had the benefit of good old Dough Boy training for some years now, the passing of this entire night afoot on reconnaissance and other missions had brought me to that point of fatigue where it seemed that each step must be my last. But in a narrow defile with the tanks bearing down upon me in the darkness, I found a supreme inspiration which kept me moving in a lively and willing manner.

All of the above mentioned vehicles going into position were equipped with the latest model of two-way radio sets in use with our army, and each radio set except one—a spare set—was assigned to a specific "net" in which it operated. All sets were silent on this secret move, as any transmission of radio traffic intercepted by the enemy would give him some indication as to our movements. With transmitters silent, each two way set had its receiver tuned to the assigned frequency with the operator lis-

tening in. The operator of the extra set was searching the frequency bands in which it was believed that the Enemy was working, in hopes of picking up something worth while.

As soon as the vehicles were all in place and dispersed to the extent that a well-placed Artillery shell could not put more than one vehicle out of action, the operator of the extra set suddenly made a surprising report to me. "Captain," he said, "the enemy is getting reports by radio as to every one of our actions. I just heard one station reporting to another the exact number of vehicles, the number of light tanks and the number of medium tanks going into one position, and in the last few minutes I have heard several reports as to our activities."

I listened to the radio. The amount of information passing over this net, an enemy net, relative to our dispositions was unbelievable! And all that I could verify was absolutely accurate. In fact I soon realized that if I listened to this net as the reports came in from Enemy Intelligence units, I could learn a lot myself as to the exact locations of certain of our own forces. Suddenly I heard, "JP8 from C44, JP8 from C44, JP8 from C44.—Vehicles, including two Medium Tanks and some scout cars, probably a Medium Armored Command Post, moved into the Turkey Ford Trail junction 1000 yards south of Turkey Ford at 4:00 am."

This was the last straw—an accurate enemy report on our own headquarters. But I had now learned a couple of Enemy call signs, JP8 and C44. I listened about five minutes longer, and picked up certain other call signs, including DK6, P89, TK6, and FK6.

I was especially curious as to the location of C44, the station that had sent that last accurate message. So, in desperation, I took a chance. Checking with my operator to see that he had his receiver tuned accurately on the frequency of C44, I had him zero beat the transmitter to the receiver, and I took the microphone. "C44 from JP8, C44 from JP8, C44 from JP8,—What is your location now? Regiment wants to know your immediate location. Important to get the answer at once. Answer in the clear. Do not take time to encode, as Enemy will not have time to act on your answer. Answer!" Then I listened.

But the operator was not so dumb. He came right back, "JP8 from C44,—Who is the operator asking for this information? I am not familiar with your voice. Who are you, and what organization do you want to know the location of? Answer!"

I was bluffing, but the stakes were heavy! The operator probably thought that if this were an enemy station interfering, he would hush up when challenged. I, however, realized that with frequent crew replacements, the operator probably did not know all of the operators with each station. Also, from the information just reported, I assumed that C44 was an intelligence unit. I gave a quick reply: "C44 from JP8. What is your immediate location? Report your location at once. Do not take time to encode, as enemy will not have time to act on your answer. Regiment wants to know the location of Intelligence platoon. This is Smith speaking. Answer!"

Somewhat to my surprise, the answer came right back in the clear. The exact location was given. It was no wonder that information had been flowing so fast from

our side to the enemy. The reporting "enemy" station was in a *concealed position in our own territory*, getting reports on all of our actions and reporting them to their Headquarters. Here was certainly an example of nerve of the first order. I made a report to our Intelligence Officer as to what I had just learned. The result was that a strong patrol was sent out to locate the *enemy* radio station, and in an attempt to escape in the darkness, the enemy scout car in which the radio was located eventually ran into the river.

Encouraged by a slight degree of success, I took advantage of another opportunity that presented itself when I heard, "FK6 from JP8, FK6 from JP8, FK6 from JP8,—Commanding Officer desires further information as to composition of Enemy Tank Forces located south of Turkey Ford. Answer!"

I wrote out a message which I had my radio operator transmit a few minutes later. It was, "JP8 from FK6, JP8 from FK6, JP8 from FK6,—Enemy tank forces previously reported south of Turkey Ford are now withdrawing down Turkey Trail to the south. Answer." JP8 receipted for the message.

Occasionally various stations of the *enemy* net attempted to transmit messages to the net control station or other stations of the net. Each time, however, as soon as the transmitting station was ready to start the text of the message, my operator, tuned in on the enemy frequency, would turn on his transmitter and put out such a continuous blast of tone signal that no station on that frequency had a chance to receive the message. Then he would sometimes listen to the station to whom the message was addressed as the operator of that station asked for a *repeat* of the message, and finally complained that too much interference prevented his receiving it. At other times my operator would deceive the enemy operator sending the message, after interfering with it to the extent that it could not be received, by receipting to the transmitting station for the message, using the call signs of the station to whom the message was addressed. This action may appear to be the same as hitting below the belt, but remember that all is fair in war, and attempting to deceive the enemy is one of the oldest tricks of the trade.

Suddenly I heard station FK6 calling JP8, indicating that he had an urgent message. I listened as the message was started, and I saw that it was a report as to the location of certain of our forces. My operator killed it at the critical point. Immediately on completion of the message, my operator sent FK6 a receipt for the message, using the call sign of JP8. Apparently the real JP8 did not know what to do, as there was silence for a few minutes. Soon, however, he called FK6 asking for a *repeat* of the last message, and FK6 started to repeat. As the operator again came to the critical part of the message, my operator, as before, blotted out the transmission with a continuous blast of tone signal, and immediately on completion of the message, sent a receipt to the transmitting station as before. The same thing happened again, and on the fourth time, my operator, tired of receipting for the same message so many times, decided to stop that message once and for all. "FK6 from JP8, I have receipted for this message three times already. Why do you keep sending that message so many times? Some station in this net does not know its call signs. This net had better get straightened out. Answer." "JP8 from FK6,—ugh—but you called—

or some one using your call signs called—and asked for a repeat of the message. That is why I have kept repeating it. Did you not ask for a repeat? Answer."

"FK6 from JP8,—I also heard a call for a repeat of that message. However, it may have been an *enemy* station asking for a repeat. I believe that was an *enemy* Intercept station getting you to repeat the message as many times as possible to give them a better chance to intercept it. Do not repeat this message any more. The more you repeat it, the more chance the *enemy* has of receiving it. Answer." My operator was doing some quick thinking.

"JP8 from FK6,—O. K. I will not repeat that message any more. That is all. End of Communication."

So actually my intercept station was doing such good work that the subordinate stations in the enemy net were accepting it as their *net control* station, and were being led to believe that their real M. C. S. was the *enemy* station. I later learned that on the basis of my message about Enemy Tank forces withdrawing to the south down Turkey Trail, the Enemy had pulled out his reserves and several of the Anti-Tank guns in the vicinity of Turkey Ford and had moved them elsewhere. So when the attack actually jumped off, the resistance at the point where the main forces crossed the river was comparatively light. The crossing was well coordinated and accomplished with very few losses, and the attack was carried on into enemy territory.

All of your agencies of defense are now exercising every means available to them to learn the ways and means whereby an ironclad defense may be set up against the successful operation of those who would deceive us. And it is the duty of every citizen of these United States to cooperate in every possible way toward achieving the same goal. I particularly appeal to all students and designers of radio, and to those who think that they might have something new or secret in theory or practice pertaining to radio communication to contact the Signal Corps, U. S. Army for a check-up as to the practicability of their ideas.

A year ago the nerve centers of a great European nation were poisoned by the interjection of venomous elements against which that nation had no antidote. And for the French they spelled DEFAITE!

NOTICE

This is the November-December issue of RADIO-CRAFT. The next issue will be our January issue; it will be published a month from the time this reaches you.

All subscribers of record will have their subscriptions automatically lengthened one month.

The Publishers

Left—Close-up of mobile 2-way radio set in U. S. Army Scout Car—antenna at "A"; right—the scout car, well armed, on its way.

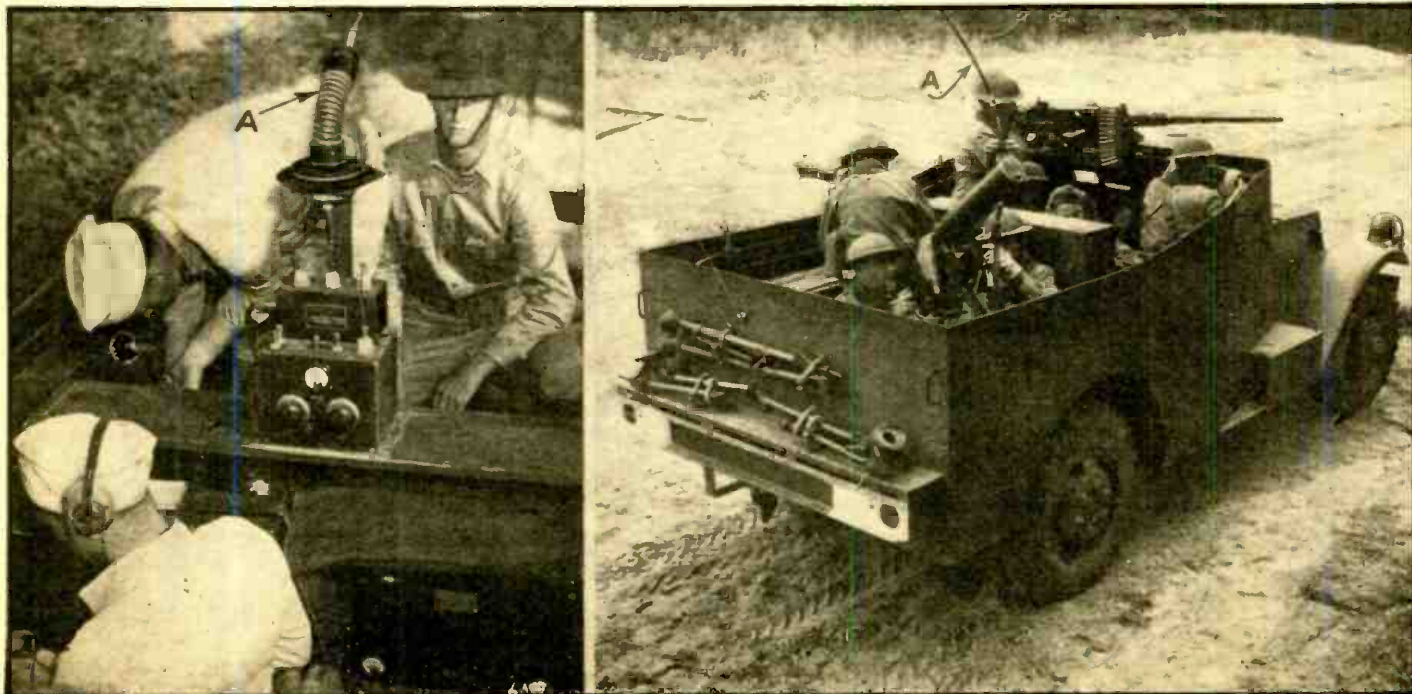

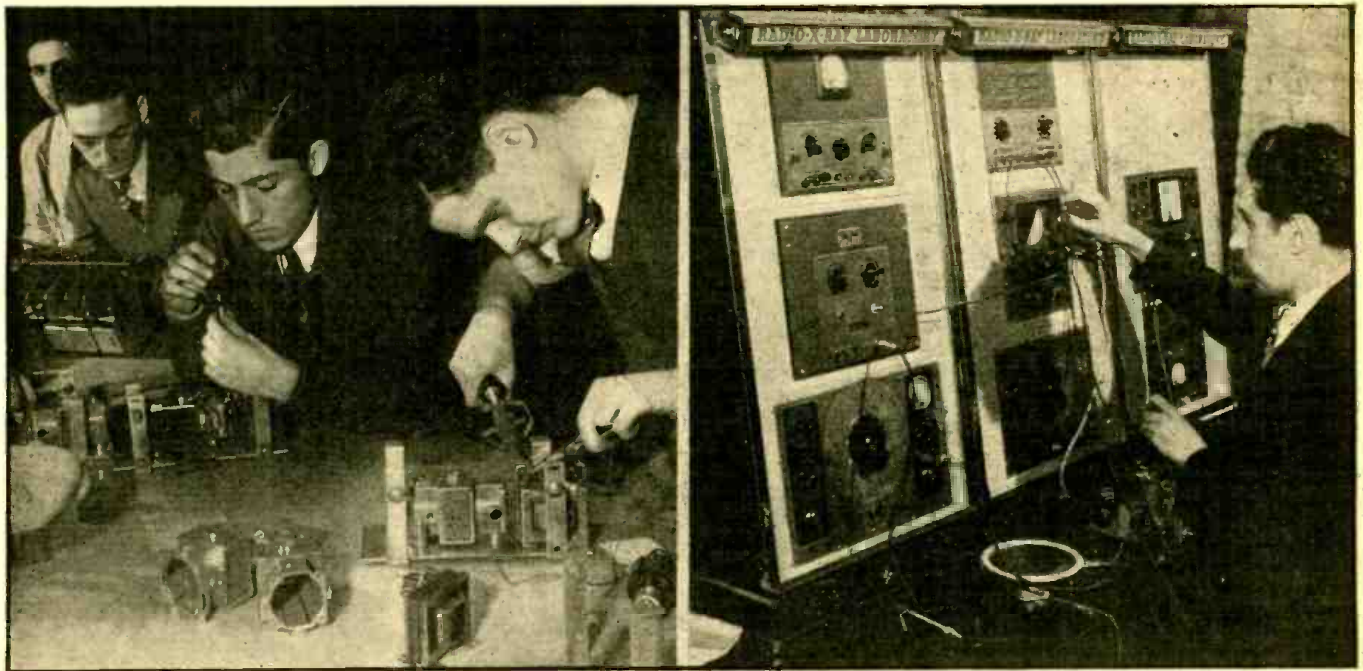

Photo at left shows American Youths receiving radio set assembly training in New York City laboratory. Right-hand photo shows NYA student checking a receiver.

HOW NYA TRAINS RADIO MEN

The New York City branch of the NYA has set up a very elaborate shop and laboratory, where hundreds of young men are being trained for radio jobs, including preparation for "Amateur" as well as "Commercial" radio operating licenses.

PREPARING young people for defense jobs in the radio technical field is an important task in these days of national emergency, and the National Youth Administration Radio Communications Work Experience Center is certainly doing more than its bit to fill the gap.

Occupying three floors of a modern, fire-proofed, factory building at 422 Eleventh Avenue in New York City, this on-the-job experience project is part of the NYA Youth Work Defense Program which has been designated by the Office of Production Management in Washington as an official training agency for the national defense program.

Already considered the most unique unit of its kind in the country, the plant offers its youth workers 160 hours of combined work experience and related theoretical training each month, for which they receive a stipend of \$25 per month to keep them going during their period of preparation. The center plans also to provide one meal a day for each worker without charge.

Under the direction of competent technicians, engineers and supervisors, the young operators and servicemen build and recondition wired communications systems, including public address equipment and wireless radiotelephones. Facilities are available for work on frequency as well as amplitude modulation receivers and transmitters. Particular emphasis is placed on the construction and maintenance of portable and mobile two-way sets.

Employing 375 young people in its various shops, the center expects to turn out workers equipped to obtain jobs in private industry and the government service in from four to twelve months, depending upon the type of work they are doing.

The plant operates on a three shift basis, with 125 workers on each shift. Each youth works 90 hours a month, and attends classes conducted by the Vocational Division of the

Board of Education for 70 hours a month. The young people are kept busy in the shops and classrooms for eight hours a day, five days a week, and four weeks a month, making a total of 160 hours.

During each shift, 57 youth workers are employed in the radio technical shop, which has set itself a twelve months training period; 28 men in the radio production shop, where it is expected to turn out competent workers in four months; and 40 men in the electrical shop, on a 4 months training course.

The shop is equipped with light lathes, drill presses, punch machines, grinders, paint and spray booth, and electric oven. Duplicating the layout of a mass production industrial plant, the center is replete with machine shop, assembly line, drafting department, testing division, research laboratory, and transoceanic code rooms.

What is more, the boys can go from one shop to another if they prove to be up to par. This enables them to acquire a well-rounded grounding in physics, code, mechanical drafting, and radio servicing. The youths take courses in these subjects in the school located in the building. Occupying a full floor of 7,400 square feet, this is the only resident school operated by the Board of Education in an NYA work center in New York.

All units in the project are organized to give the youths a full program covering all phases of radio physics and electronics, explained Morris Segal, Director of the Center.

"The wide scope of our program will take NYA youths well above the level of the average radio mechanic to a point where they will be ready to follow a career in the radio field, whether it is in marine operating, broadcast work, manufacturing, or in the armed services," Mr. Segal said. "Every phase of our work is designed to equip and encourage youth to be of value to the radio industry."

"The new defense set-up, utilizing 90 hours per month of work experience and 70 hours of required related training, instead of the previous 60 hours of work and optional training, places the Radio Communications Center on a very firm basis."

The young people at the Center receive their work experience on sponsored materials, on transmitters and receivers belonging to city, state and federal government agencies. Thus they tackle real work problems on jobs that actually need to be done.

Youths at the center are also given the opportunity of preparing for commercial radiotelephone, radio telegraph and 'ham' licenses. When the youth workers receives his amateur rating he automatically becomes a member of the radio club which operates the NYA built transmitter of Station WNYA located at the center.

The station, whose official call letters are W2NKY, operates on 500 watt power output. This station is a link in the chain of more than 46 NYA operated transmitters located throughout the country. Affording nation-wide coverage, this network is ready to be put into service as a communication line in the event of a national emergency.

Before they can be assigned to the Radio Communications Center, the youths are required to take 18 tests at the NYA's Aptitude Testing Unit. These tests, measuring general levels of ability, code aptitude, radio trade information, and work sample practice, make it possible to select in advance those workers who are most likely to be suited to work in the radio field. After adaptability to production or technical work is determined, the boys are given the type of job they can do best.

Altogether, the Center boasts of a 22 per cent turnover into private industry every month, with much greater prospects as the defense program develops and the 160 hours schedule begins to raise the level of training.

ALLIED RADIO
CORPORATION

More Than Ever— YOU NEED THIS 1942 ALLIED RADIO CATALOG!

Everything in Radio at Lowest Prices

FOR SERVICEMEN • DEALERS • SOUND MEN • AMATEURS • BUILDERS

Today, more than ever, ALLIED is the one name that means Everything in Radio. Today, more than ever, you can always depend on ALLIED for vast, complete stocks of the leading makes of diversified equipment in every field of radio and electronics. You can always depend on ALLIED for quality merchandise that's "tops," for rush-service direct to you on all orders. For those extra values you'll not find equalled anywhere in radio today. There's never been so complete, so value-packed a catalog as the new 1942 ALLIED book—the FREE 212-page Catalog you'll need to keep up with radio. Servicemen, Dealers, Amateurs, Sound Men, Experimenters—send for your copy of Radio's Greatest Catalog with the lowest prices in the entire field.

**Free
RADIO'S
GREATEST
CATALOG**

**212 PAGES!
BIGGEST
EVER!**

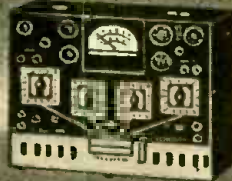

50 NEW SET MODELS

You'll want to see the 1942 KNIGHT "Radio Hit" models—more than 50 of them—featuring the newest styling, latest developments, low prices that can't be challenged. There's a radio for every room—New FM-AM models; luxurious Phono-Radio Period Models; new continental-style plastics; Table Models; portables, recorder-radios; farm sets; auto radios—radios for every purse and purpose!

KNIGHT SETS PA PAGE

There's a big new section devoted 100% to PA. New Systems—7 to 60 watts; new biased-power amplifiers; new-type "Bantam" Portable Systems. Everything in microphone, speaker and phono accessories; valuable data and charts on how to select the right sound system. Get facts about our 15-Day Trial Offer and Easiest Time Payment Plan in PA! Write for FREE competent advice regarding PA problems.

BIG SERVICE SECTION

The most complete catalog in all radio's history—nothing like it ever before. Page after page of the very latest quality Test Equipment—all the leading makes—all the newest gadgets, tools, books, to make service work easier, faster, and far more profitable. And more than 50 pages devoted exclusively to replacement parts for repairing any make and model radio. It's the Serviceman's Buying Guide!

BOOK HAMS LIKE BEST

And there's a reason, because the 1942 ALLIED Catalog is packed with the most complete Amateur listings in our long history. All the new communications receivers; new x-mitter kits; tubes; keys; accessories; replacement parts; specialized electronics equipment—everything in radio for the amateur is combined in one exclusive and clearly tabulated section. Amateurs may use our liberal time payment plan.



BUILDERS' GUIDE

Nothing like it for the Builder and Experimenter has been published before. After page of new build-your-own kits; the popular "DX-ers" in new versions; new FM kits; "Popular Mechanics" Kits; dozens of new diagrams, circuits; everything for the Radio Builder and Experimenter! We'll supply FREE parts lists for any circuit described in magazine construction articles. You'll want this great 1942 Catalog—send for it now!



MORE THAN 15,000 PARTS

Today, more than ever, you can count on ALLIED'S vast stocks for everything you need in radio. Our experienced staff of merchandising specialists have spent months in combing the market to maintain and build up the most complete stock in radio's history. All the famous makes are offered; complete listings in every field are available—and all at lowest prices. Don't miss the big special Bargain Section that sets new value records for 1942!



FLUORESCENT LIGHTING

For those extra profits, and extra savings, see our completely new Fluorescent Lighting rotogravure section. Here's a wide variety of low priced easy-to-install new fixtures and accessories for commercial, industrial and home lighting applications—at new low prices that will amaze you. It will pay you large dividends to investigate this profitable new field! Clip the coupon below for the most reliable fluorescent guide to complete stocks.

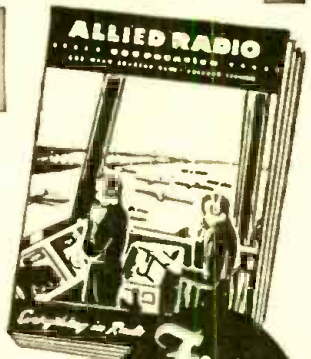

**Free
SEND
COUPON**

ALLIED RADIO CORP.
833 W. Jackson Blvd., Dept. 2-M-1
CHICAGO, ILL.

Rush me a copy of your FREE 212 page Complete Radio Catalog for 1942.

Name

Address

City State

ALLIED RADIO

833 W. JACKSON BLVD. • CHICAGO

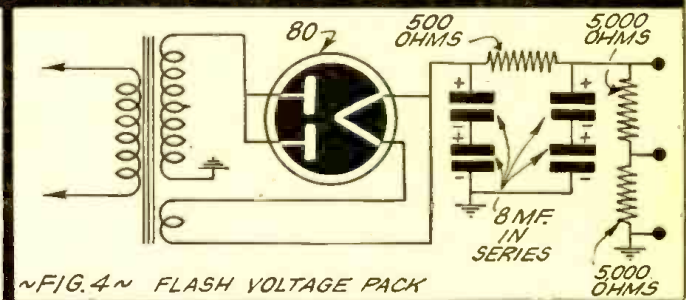
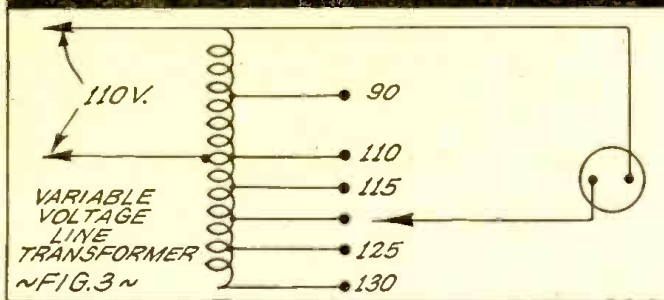
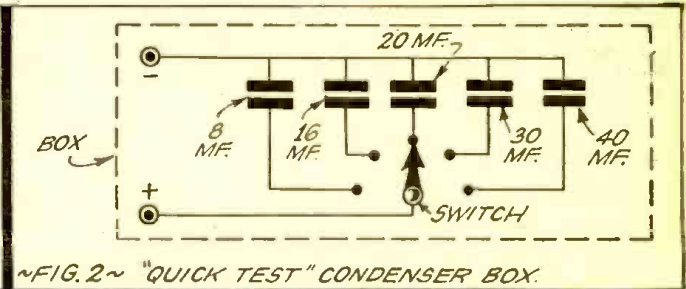
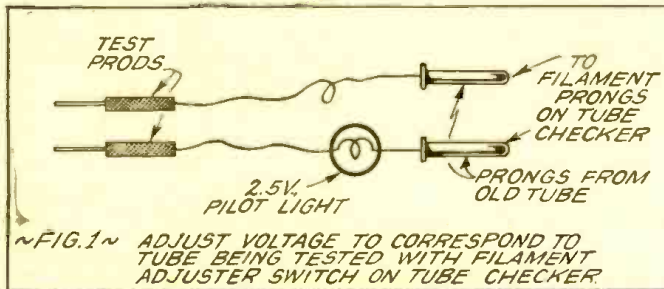

Several methods which will help to speed up servicing are shown above and explained in the text.

SPEEDY SERVICING

SPEED! SPEED! SPEED!

HAROLD DAVIS

SPEED is probably the most important word in Radio Servicing. Mr. Davis points out several ways in which you can speed up your servicing. He explains how to speed up the locating of "Intermittents," along with many other valuable hints.

THE ability to go places faster and do things quicker.

The keynote of a war-crazed world. An absolute necessity in the successful management of a modern competitive business.

And—radio servicing is a modern competitive business!

The need for speed in radio servicing has long been recognized by those who have seen a volume of radio business move through the larger shops. Since the debut of the small midgets, a majority of all servicing has been of this type. For years the question has been, "How are we going to make money servicing midgets?" The answer is and always has been—turn out more of them!

HOW?

This statement brings on the natural question—HOW? And, the answer to this one-word inquiry requires careful attention and consideration.

Looking at the rosy side of the picture, there are several things in favor of the midget. First, it is usually brought in by the customer, thereby eliminating the necessity of making a call. Few servicemen realize what it costs them to make calls. Besides the actual time lost, there is the question of automobile expense. It costs money to sit and wait on a red light, and it is your time that is wasted when you stand in the doorway and listen to a customer jabber about something that doesn't mean a thing to you. It is almost impossible to charge enough for service calls to break even on them.

Second, since the customer brings the set in, he usually returns for it, and it is a well-known fact that customers pay better

when they come to the shop for their sets. The more cash business a serviceman can get, the less time he has to spend in book-keeping and collecting. And, it might be mentioned that getting the customer into the store or shop affords the alert serviceman an opportunity to show or sell him additional merchandise.

Getting right down to technicalities, the little sets are far easier to service than the big sets—that is, if you know your stuff! All servicemen will agree, I think, that in the majority of cases defective tubes are the cause of midget set failure. In a majority of these cases, it is the power tube. In approximately half of the power tube cases there is filter condenser trouble.

Accordingly a simple routine for servicing midgets is to first check the tubes. Since tube failure is practically always caused by open filaments, if some simple means is used to check filaments without the necessity of placing each tube in a checker and waiting for it to heat, considerable time can be saved. There are several ways to do this, the simplest being to utilize the ohmmeter. If a low scale is used open filaments can usually be detected without removing the tube from the socket. However, occasionally the circuit will afford a round-about reading that is misleading. A simple gadget for checking filaments quickly can be rigged up with the aid of an old tube-checker. A pair of test leads are rigged with tube prongs on one end so that they can be inserted in the filament positions of one of the sockets on the tube checker (Fig. 1). A pilot lamp of the 2.5 volt variety is wired in series. The proper voltage is fed from the tube-checker through the pilot lamp and to the tube as the test prods are touched across the filaments. If the filament of the tube

being tested is out, the pilot lamp will not burn or will burn very dimly.

"FILTER CONDENSER" TROUBLES

On midget sets, filter condensers are found open more often than shorted! If the power tube is okay but voltage is low or insufficient to read, one or both of the filters are usually open or have lost their capacity. All servicemen are accustomed to placing another filter across the various sections to locate the defective one. This is usually a tedious job, between trying to make connection and keep from getting shocked. However, if a few minutes are given to installing a series of condensers with a switching arrangement in a box which has provisions for plugging in a pair of test leads, not only will this job be speeded up, from the standpoint of locating the proper condenser, but also in determining the proper value to use in the replacement (Fig. 2).

A few precautions are in order here. If one section of the pack only is replaced, the other should be checked thoroughly for both leakage and capacity. The section replaced should always be removed from the circuit as defective low-capacity condensers are low power factor, and cause an unnecessary drain on the circuit, even if they do not become heated and short.

Some servicemen are of the opinion that the only requirement for the replacement of a filter is to get enough capacity. This is not always correct, especially in the case of close cathode rectifiers such as the 25Z6 and 6X5. If too high capacity condensers are used immediately following these types, the condensers can pull enough current on quick charges such as occurs when the set is turned off and on rapidly or during line

interruptions, to completely melt the cathode. This is what happens when a filter shorts and often happens when the serviceman shorts around in the set with a screw-driver to see if he has any voltage.

However, it is safe to use 16-20 mf. and if this amount eliminates the hum, no increase should be made unless the proper value is known.

Other common defects with the little "midget" sets are the general run of trouble, *shorted bi-passes, open fields and output transformers* and I-F's. However, these troubles are scattered and easily isolated.

ALIGNMENT

Very frequently the serviceman will neglect *aligning* the "little fellows," because he does not feel justified in wasting the required time to do the job right. Excellent alignment can be obtained in only a few minutes with the following procedure. Connect the oscillator to the antenna and ground connection through a 100,000 ohm resistor or .0001 or .00025 mf. condenser. Feed in an I-F signal and stop the oscillator by placing a finger on the oscillator section of the tuning condenser. This stopping of the oscillator is not always necessary but is advisable. Adjust I-F's to maximum signal with set volume control "wide open" but oscillator turned down to where the signal is barely audible. If a low signal is used, the set can be peaked by ear, without hooking up an output meter.

When the I-F's have been aligned, the R.F. and Oscillator trimmers can be adjusted by switching the signal generator to 1400 kc. or by removing it entirely and tuning in a weak signal in the vicinity of 1400 kc. The latter method is preferred.

Loop Sets: On sets using loops as both antenna and antenna transformer, coupling is best accomplished by feeding the signal generator into a loop of similar size and number of turns, and holding this loop near the one in the set. Such a loop is easily made by winding a few turns of wire on four nails correctly spaced on a piece of ply-wood, and will serve for testing practically all loop sets.

SPEEDING UP THE INTERMITTENTS

Nothing slows up service work more than *intermittents*. And there is no known system that will solve intermittents consistently. The busy service man can save himself much trouble and time by proceeding cautiously when he is called to service an intermittent receiver. If the set is cutting out only occasionally and if there is nothing that can be done to make it cut out, it can best be left alone. The customer should be told to use the set until it *quits for good!* Many unprofitable hours can be saved, even though it may seem at the time that business is being lost.

If, however, the intermittent is fairly consistent and of a definite nature, it is up to the serviceman to find this trouble in the least possible time. The most successful way to do this that this writer has found is to break the defective part down. This is done by applying *high voltage* to the parts suspected of causing the trouble.

The best way to do this is to have a power-supply capable of delivering a flash voltage of 800-1000 volts. This can be probed across condensers, resistors and coils, and while not high enough to short a good condenser or open a good resistor or winding, will often break down defective parts. In the case of AC-DC sets, the voltage has to be reduced accordingly.

High voltage not only breaks down defective parts, but will also show up loose connections and intermittent grounds. Recently the writer had a Philco 610 that had a scratching noise like a defective output

or driver transformer. All ordinary checks revealed nothing. The trouble was isolated to the plate circuit of the first audio, but a substitute of parts did not clear it up. However, high voltage touched on the plate with the set off, stopped the noise immediately and although several months have passed it has not returned. No cause for it was ever found.

Another case was an RCA that tuned in a station on 850 kc. at 600 on the dial and would pick up nothing on the high frequency end. Hours were spent checking. It was found that the oscillator was far *off frequency*, but no cause could be established. Finally, the high voltage was applied and an arcing was observed under the tuning condenser. It was found that the bond from the tuning condenser to chassis was a cold joint. The high voltage arced across, showing it up.

Sets can be operated on the high voltage by removing the power tube and feeding the external high voltage onto the filament or cathode. When the set becomes good and hot, the intermittent will usually show up.

Some intermittents are allergic to low voltages instead of high. A variable line transformer, Fig. 3, which can be bought for a nominal sum, will serve to vary the line voltage both *above* and *below* the normal value. Low voltage will cause a weak oscillator to cut out or it will cause *distortion* and *drifting*.

When the set is checked on high voltage it not only raises the D.C. supply, but also increases the filament voltage, causing the tubes to get hotter and thereby breaking down internal shorts, weak filaments and other troubles.

A pack for supplying the high flash voltage is shown in Fig. 4. This is built with parts that can usually be found lying around. The gadget will save many hours, and if used to final check all sets that go through the shop, the number of kick-backs will be reduced to a minimum. The parts lost in the application of the high voltage that might otherwise get by are negligible.

CONSERVING SKILLED LABOR

Not only must the modern serviceman apply every known trick to turn out his work *faster*, but as more and more men are called into the Government service, a conservation of skilled labor is going to be found necessary. This can be done by diverting into the hands of others that part of the service work that does not require technical knowledge. This represents removing sets from cabinets, cleaning, checking tubes, installing parts, etc.

A simple and effective routine is to have the *non-skilled* man remove the chassis, clean it and check the tubes. He then passes it to the serviceman, who diagnoses the trouble. While the set is being diagnosed, the helper cleans and polishes the cabinet and removes the second chassis. The serviceman passes the diagnosed set back for the installation of the defective part. While the helper installs the part, the serviceman diagnoses set number 2. He then passes set number 2 to the helper for installation of part, and takes set number 1 for final check. No time is lost and maximum efficiency is obtained from both serviceman and helper.

Careful diagnosis of the job from the standpoint of how long it will take and how much can be realized for it, will save the busy serviceman much time and trouble. Jobs that are not routine should be avoided whenever possible. Or at least they should be on a *time plus material* basis. The serviceman must get at least \$3.00 per hour for his time and facilities. He should get \$5.00, which is the price charged for work at machine shops, sheet metal shops, etc.



In these and similar batteries and electric ovens every Triplett Instrument is subjected to scientific heat treating during several stages of assembly process. Pre-curing of molded parts and heat treatment of all assembled materials is a precaution to eliminate strains and stresses which otherwise would develop after the instrument is in the hands of the user. This is one of the many Triplett methods of insuring your continued satisfaction with Triplett Precision Instruments and Testers. Accurate alignment for dependable performance is thus assured under all normal conditions and usage."

THE TRIPLETT ELECTRICAL INSTRUMENT CO.
Bluffton, Ohio

DATAPRINTS



TESLA-LOUDIN COILS

- 20c Ea. in order for 10 (Data and Drawings only)
- 36" Sp'k Tesla-Oudin Coil 40c (1 K.W. Exc. Trf. Data incl.)
- 8" Sp'k Tesla-Oudin Coil 40c (1/4 K.W. Exc. Trf. Data incl.)
- 8" Sp'k Oudin; 110 Vt.
- "Kick Coil" type 40c
- 3" Tesla Works on Ford Coil 40c
- 1" Sp'k Vibrator Hi-Freq. Coil 40c
- NEW! 5 ft. Sp'k. Oudin Coil & Exciter Data 75c



Induction PIPE & ORE LOCATOR

- Induction Type, Data 40c
- Radio Type 40c

More DATAPRINTS 40c each!

- 5 Meter Superhet.
- 1/2 Meter Tr. & Rec.
- 20 A.C. Probs. & Ans.
- 20 Telephone Hook-ups
- 100 Mech. Movements
- 20 Motor Hook-ups
- Television Hook-up
- 20 Elec. Party Tricks
- Solenoids and Magnets —get list.
- Fry Eggs on Ice!
- Experimental Telephone
- Radio Control for Models
- Diathermy Apparatus
- Inductor Organ
- Electric Refrigerator
- Wheatstone Bridge
- Weld. Transf. 2 K.W.
- Rewinding Armatures
- String Galvanometer
- 20 Simple Bell Circuits
- Steel Wire Recorder!
- Water Wheels
- Water Turbines
- Photo Cell and Relay
- Ring 4 bells: 2 Wires
- 20 Tesla Tricks
- Polarized Relay
- Induction Balance
- Electric Pipe Thawer

Special Prices: 4 prints \$1.00; 10 for \$2.00; Single, 40c each. Get New Catalog 100 A.

The DATAPRINT Co.
Lock Box 322D, Ramsey, N. J.

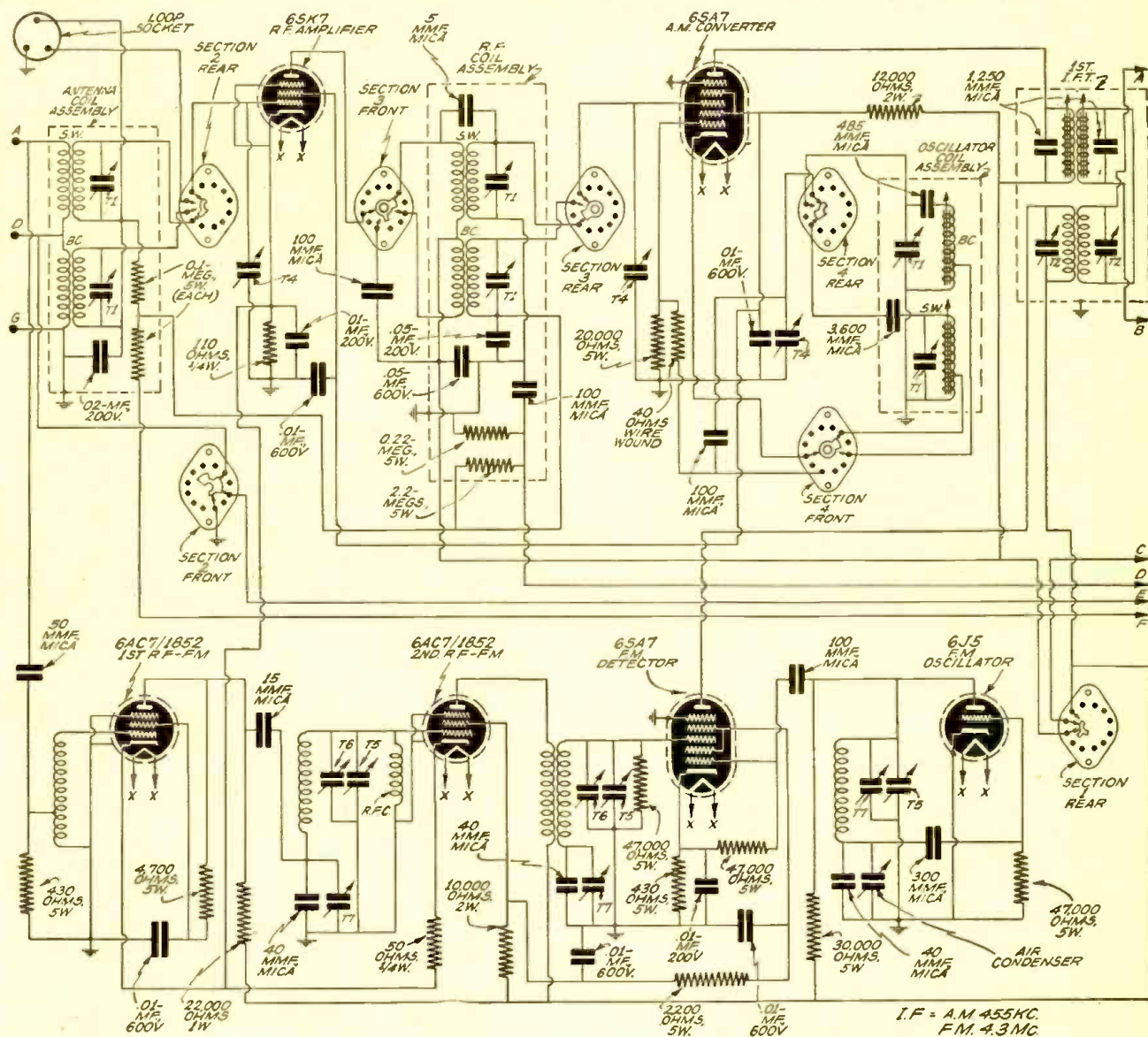

PILOT MODEL 200 SERIES FM-AM RECEIVER

OPERATING AND SERVICE INSTRUCTIONS
Model 200 Series
FM, AM RECEIVER

SPECIFICATIONS

Voltage Rating — 110-125 volts, 50-60 cycles AC

Combination Frequency Modulated and Broadcast and shortwave amplitude modulated receiver — provision for microphone and phono pickup or television converter provided.

TUNING RANGE

FM: 41.8 to 50.3 mc
AM: Broadcast—535 to 1720 kc or 561 to 174 m.
Shortwave—5.6 to 19.8 mc or 53.6 to 15.2 m.

NUMBER OF TUBES AND TYPES

FM—R.F. No. 1 —6AC7/1852
FM—R.F. No. 2 —6AC7/1852
FM—detector —6SA7

FM—oscillator —6J5
AM—R.F. —6SK7
AM—converter —6SA7
FM—AM 1st I.F. 4.3 mc—455 kc —6AC7/1852
FM—AM 2nd I.F. 4.3 mc—455 kc —6AC7/1852
FM—4.3 limiter —6SJ7
FM—detector —6H6
FM—tuning rectifier —6H6
AM—detector & FM QAVC —6SQ7
FM—AM Voltage Amplifier —6SJ7
FM—AM Cathode loaded driver —6J5
FM-AM Push Pull AB2 amp. —6L6
FM-AM Push Pull AB2 amp. —6L6
Rectifier —5U4G
Tuning Beacon —6U5/6G5

FEATURES

This Pilot dual superheterodyne using two tuned R.F. stages for FM and one tuned R.F. for AM, provides static-free full-fidelity reception by the Armstrong wide-band Frequency Modulated system

as well as superior reception of the AM broadcast and shortwave bands. One dial and one set of controls are used for all services. Five controls are provided from left to right; they are:

1. The volume control with low-level bass and treble compensation.
2. Tone Color control which provides adjustable bass and treble compensation at higher audio levels. The knob for the tone color control operates a pointer which indicates on the dial scale the tone color positions, which are:
 - a. Bass—this position provides a high bass & lowered treble tone
 - b. Music—high bass & high treble tone
 - c. Voice—lower bass & lower treble tone
 - d. Treble—lowered bass & high treble tone
3. The Harmonic Control & QAVC switch: This control provides a very

Radio Service Data Sheet

318

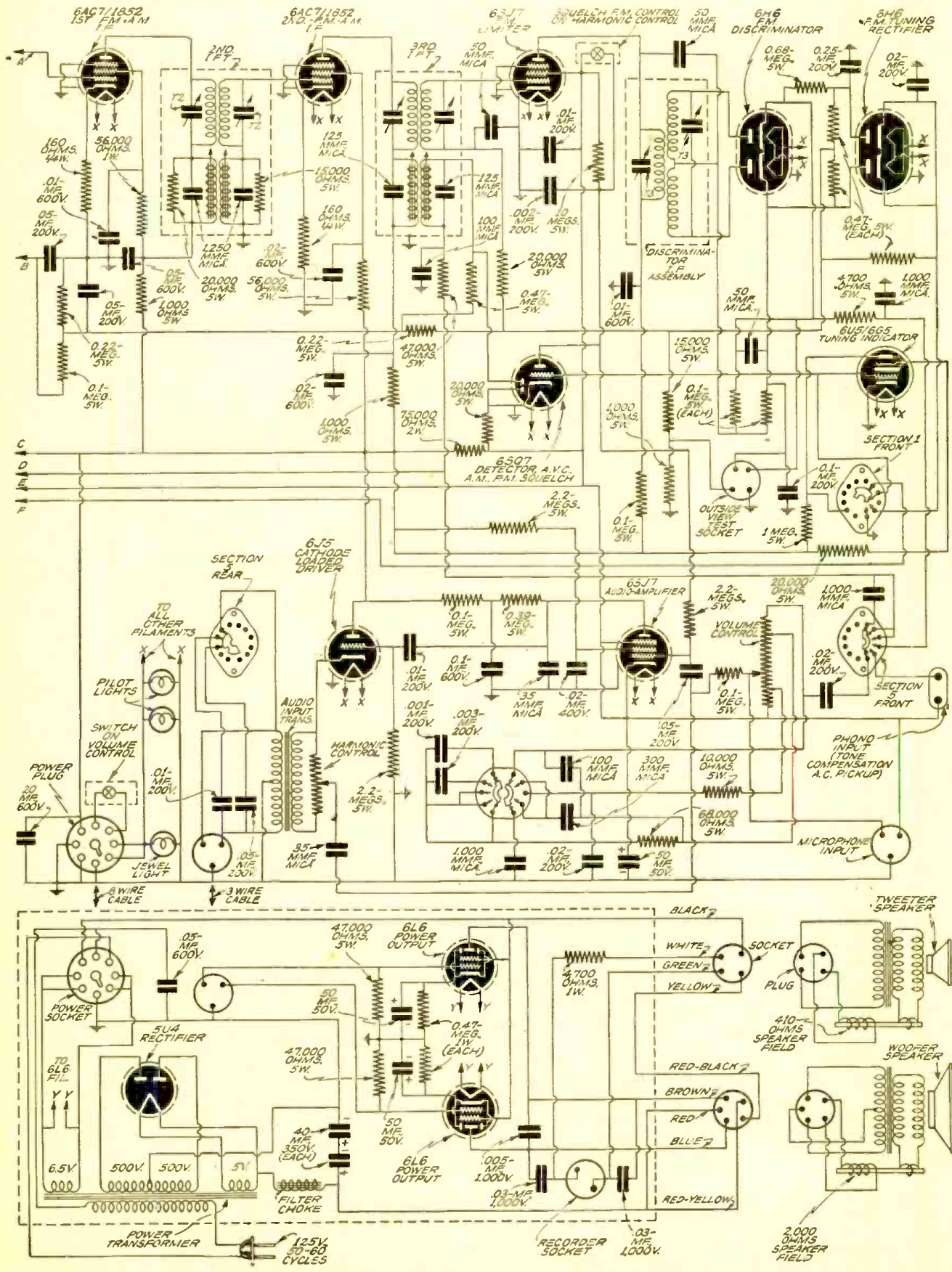

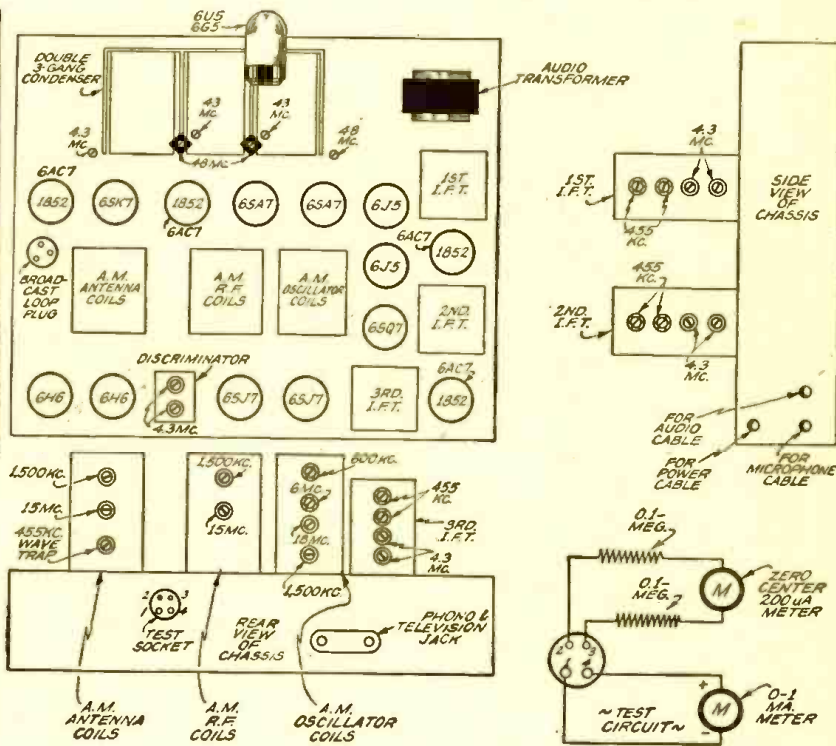

sharp cut-off of the higher audio frequencies and operates in an inverse feed-back circuit.

It will usually be desirable to keep this control at less than maximum setting when listening to recorded and live programs on AM and phono.

Rotating the harmonic control to the extreme left until a click is heard cuts out the QAVC on FM and this position is meant to be used on very weak FM signals. These must be tuned very carefully as the tuning beacon cannot function properly on very small signals. The higher harmonics are automatically removed in order to reduce external noises introduced with extremely low signals. The tuning buttons should not be set on any station which can only be received without the QAVC.

4. Band Selector: This control selects the type of service desired. The knob for the Band Selector operates a pointer which indicates on the dial scale the Band Selector positions which are:
 - a. Short Wave—AM
 - b. Broadcast AM external Antenna
 - c. Broadcast AM internal loop antenna
 - d. FM external antenna
 - e. Phono-Television accessories

In the phono-models the phono pickup is built in and connected in this position.

A Television adapter connected to the pin-jacks provided at the rear of the chassis will permit the user to use the same audio system and dual loudspeakers for Television Sound, and this can be controlled with the Service Selector.

5. Tuning Control: This control operates the FM-AM, broadcast and shortwave, and should be rotated very carefully to provide maximum reception. Careless tuning will not permit the automatic volume control to function properly and distortion and poor tone will result.

OPERATION OF PUSHBUTTONS

This set is provided with eight push-buttons which mechanically operate the dual 3-gang tuning condenser. These may be set on AM and FM in any combination, that is, 5 for AM, 3 for FM, etc.

To set up these buttons pull off the

bakelite caps and loosen the locking screw. Tune in the stations with the tuning knob and push the flat piece of the control all the way in. Then tighten the locking screw. A careful check with the tuning eye should immediately ascertain the exactness of the setting.

On very weak signals it may be necessary to retune the station very slightly with the tuning knob. It is recommended, however, that the left buttons be set on AM locals and the right buttons be set on FM locals.

Slight misadjustments due to continuous use will cause little effect on the tone as this FM-AM I.F. system is expressly designed for push-button use.

ANTENNA

A good antenna system cannot be overemphasized and should the receiver be used in the locality of any vertically polarized FM transmitter, best reception from that station at a slight sacrifice of the reception of the usual horizontally polarized transmitters can be secured by tilting the dipole to about a 45° angle. The whole array should then be rotated for best average reception of all the local stations.

Maximum pickup from a given transmitter is usually secured when the broadside of the dipole antenna faces the said transmitter.

SERVICE NOTES

This receiver has been correctly aligned at the factory and no further adjustments to either the trimmers or iron cores are recommended.

The minimum requirements for satisfactory adjustment of the trimmers, etc. are:

1. 0 to 1 milliamper meter, preferably

with an extra 5 milliamper shunt resistor.

2. Zero center. 0 to 200 microampers galvanometer and two 100,000 ohm resistors.
3. Rectifier type output meter of approximately 0 to 2 volts R.M.S.
4. 65 ohm FM dummy antenna. 400 ohm shortwave dummy antenna. 200 mfd. AM dummy antenna. .1 mfd. I.F. dummy.
5. Accurately calibrated signal generator capable of supplying 0.5 to 100,000 microvolts at the following frequencies, which constitute the order for adjusting and balancing the receiver:
 - a. 455 kc I.F.'s and wave trap
 - b. 4.3 mc I.F.'s and discriminator oscillator
 - c. 600 kc antenna, R.F. and osc. and loop
 - d. 1500 kc osc. rock-in
 - e. 600 kc osc.
 - f. 1500 kc osc.
 - g. 6 mc osc.
 - h. 18 mc osc.
 - i. 15 mc ant. R.F.
 - j. 43 mc osc. 2nd R.F. & 1st R.F.
 - k. 48 mc osc. 2nd R.F. & 1st R.F.
 - l. repeat 43 & 48 mc adjustments and slightly rock-in variable

The antenna circuit has no adjustments for FM and is expressly designed for the Pilot FM-AM dipole antenna #110-7.

The zero center galvanometer is used to set the discriminator secondary trimmer and the FM oscillator trimmer and padder.

The 0 to 1 milliamper meter for 4.3 mc I.F. & FM R.F. trimmers and padders.

The AC output meter across the voice coil and only for AM adjustments.

The volume control should be on full for all final AM adjustments.

HARD TO BEAT !!

HOWARD'S *High Class* PERFORMANCE!



PLUS
LEO'S
[W9GFQ]
High Class
SERVICE

\$164.50 Complete with crystal and tubes, less speaker. 10" P M Howard-Jensen speaker with cabinet \$12.50

Howard receivers are reliable receivers made by America's Oldest Radio Manufacturer. The *Howard 490* has 14 tubes, 2 stages of R F preselection, calibrated band spread, air-tuned I F transformers, variable I F selectivity, temperature compensated oscillator, split stator ceramic insulated tuning condensers, variable fidelity audio, 8 watts push pull output, automatic noise limiter and tunes from 540 Kc to 43 Mc.

Send in your order. I'll make prompt shipment on these sets or anything else you may need.

If you want to trade in your old receiver or any spare equipment and it is nationally known—I'll give you top trade-in allowance. Write me before you make *any* deal!

No need to pay all of it now—I offer you the lowest 6% plan available on any nationally known receiver, xmtr, or parts shown in any catalog or advertisement at the lowest price shown. LET'S GET ACQUAINTED.

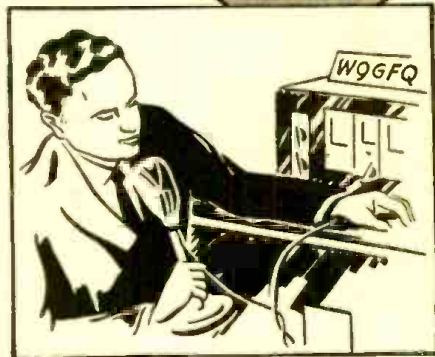

MODEL 435 A

A 7 tube receiver for short wave fans who desire reception from all over the world. Has 4 bands from 540 Kc to 43 Mc, tuned R F on all bands, AVC "off-on" switch, A F gain control.



Complete with tubes and speaker \$36.75

FREE

A big U.S. map measuring 3½ ft x 4½ ft, in two colors. Shows time zones, amateur zones, monitoring stations and principal cities. 15c to cover packing and postage brings one to you.

GET MY BIG ILLUSTRATED CATALOG. It shows everything I carry in stock—receivers, xmtrs, parts, supplies, accessories. Many of them new and exclusive.

Investigate my own WRL xmtr kits from 15 watts on up. It will pay you. *Special low prices* — for instance my 70 watt xmtr kit @ \$35.00. Write for details now!



MODEL 437 A

Finest of all moderately priced communications receivers. Has 9 tubes, all features of 435 A and 436 A plus crystal phasing control, two iron core transformers, I F stage, and noise limiter. Gets stations quickly.



Complete with tubes and speaker, less crystal \$61.95

Model 436 A also carried in stock as well as Howard accessories. Write for circular.

Wholesale RADIO LABORATORIES

744 WEST BROADWAY—COUNCIL BLUFFS, IOWA

INTERFERENCE ANALYSIS

W. J. ZAUN

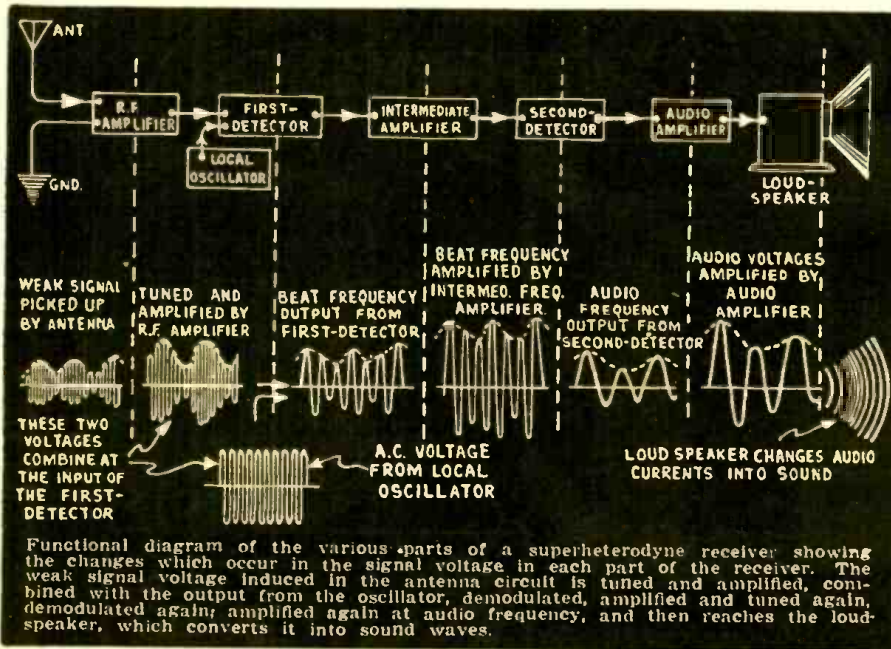

This diagram shows graphically the action taking place in a superheterodyne receiver.

I. IMAGE RESPONSE

ON the basis of present practice in superheterodyne design, when a receiver is tuned to a given signal, the local oscillator is at a frequency the amount of the I.F. above the signal frequency. The difference in the oscillator and station frequencies is the nominal I.F. and signals of this frequency are amplified and transmitted to the second detector of the receiver for demodulation. Should a second incoming signal be present, whose frequency is above the frequency of the local oscillator by the amount of the same I.F., it will likewise tend to combine with the oscillator and produce a difference beat which will appear in the I.F. system, and finally at the second detector stage. The interference is heard as a "whistle" or as mixture of modulations of both signals. In this case, considering the oscillator at a particular frequency, there is a signal below it, by the amount of the I.F., and there is a signal above it by the amount of the I.F. The undesired second signal when attenuated or when not allowed to mix with the oscillator, causes no interference. However, if it is possible for this signal to reach the first detector stage, it will also beat with the local oscillator signal when tuning to the desired station. This condition is referred to as "image response." It is a function of the degree of selectivity ahead of the input to the I.F. system.

Effects of interference from this cause may be reduced by suppressing the strengths of the undesired local stations which are producing the images. This can be done by reducing the receiving antenna efficiency, or by using wave traps tuned to the "image" station. It must be noted, that harmonics of local broadcast stations, harmonics of the local oscillator, and stations operating outside the limits of the standard broadcast

band, oftentimes are sources of "image" interference. Particular attention must be given to the 1700 kc. Police Band, the 2000 kc. Amateur Band, and the 2500 kc. Police Band, in cities where image interference exists. Variation of the I.F. is another means of correcting the condition.

II. HARMONIC OF I.F.

When a signal is being received whose frequency is twice that of the nominal I.F.; or within a range of plus/minus 10 kc. of twice the I.F., there will appear in the output of the mixer stage a second order effect,

Many forms of radio interference occur, each arising from particular causes or circumstances, and each producing typical effects upon reception. Disturbances such as man-made and natural static are rather complex in nature, and are not subject to simple analysis nor cure. Other interference phenomena, however, which are associated with signals having definite wave character, frequency disposition, and intensity, and which bear a relation to receiver characteristics, may be examined conclusively. The more commonly experienced troubles of the latter type are treated herewith.

or the difference between twice the signal frequency and the oscillator frequency. Whenever the signal frequency is twice the I.F., the normal I.F. will be produced in addition to the spurious I.F. which is due to the beat between the second harmonic of the signal and the heterodyne oscillator. Since the standard I.F. and the extra I.F. vary at different rates as the receiver is tuned, a whistle will be heard. Selectivity cannot discriminate against this type of whistle as only a single signal is involved.

Since the number of cities having stations which operate on the second harmonic of

I.F. frequencies used at the present time, is limited, this interference does not become of general concern, but applies only to the particular locality where the station is situated. Realignment of the I.F. stages of any receiver affected, is the usual cure for trouble of this sort. It should be carefully noted and checked as to whether the signal operating at the second harmonic of the I.F. is being picked up on the under-chassis wiring of the receiver, in addition to the antenna. In this case the whistle produced will be aggravated. In extreme cases, it is possible to eliminate the whistle by providing a wave trap, tuned to the second harmonic of the signal, and placed in the circuit feeding the mixer stage.

III. DIRECT I.F. RESPONSE

When there is a signal present in the receiving locality, whose frequency is the same as that used for the I.F. of the receiver, or near thereto, direct pickup of the signal may take place and interference will be reproduced. This interference is not affected by tuning of the receiver, inasmuch as it has a frequency corresponding closely to the fixed I.F. resonant circuits. It enters the receiver through the antenna and first stage in most cases, but may be introduced by direct induction to the I.F. system.

The degree of interference is related to the amount of I.F. attenuation provided in the pre-selector circuits ahead of the I.F. system. It is usually evidenced in the form of a "birdie," or in the form of a tone, depending on whether the interfering signal is using CW or ICW during its transmission. The stations which are apt to give interference in the 450-470 kc. intermediate frequency range, are used for code communication and are generally coastal shore to ship stations.

Wave traps in the antenna circuit tuned to the exact frequency of the interfering

signal, are effective in reducing this type of interference. In some cases it is necessary to shift the I.F., either up or down, to get away from the interfering station. Use of an RCA Magic Wave Antenna provides an attenuation of approximately 6/1 in the I.F. range.

IV. HARMONICS OF OSCILLATOR

The presence of short wave code or short wave broadcast signals within the standard broadcast band is generally due to their combination with the upper harmonics of the receiver's oscillator; the difference of

*Service Department, RCA Manufacturing Co., Inc. Illustrations courtesy "Radio Physics Course"—An Elementary Text Book on Electricity and Radio, by Alfred A. Ghirardi, E.E.

the station frequency and harmonic frequency being equal to the I.F. Spurious reception of this type is most prevalent on receivers employing loop antennas.

Electrically, an antenna loop has the character of a long line having several resonances in addition to its fundamental tuning. The secondary resonance effects may fall into and provide substantial gain in causing an appreciable level of short wave signal to appear at the first stage.

When this signal is of such a frequency as to combine with a harmonic of the oscillator, and produce I.F., reproduction takes place the same as with the fundamental signals.

Proper treatment of this type of interference should be along the line of (1) Orienting loop for minimum pickup of interfering SW station, (2) Re-aligning loop carefully, (3) Substituting conventional antenna coil for loop, (4) Decreasing oscillator excitation by shunting tickler section with a resistor, or taking turns off this same winding.

V. COMBINATION OF I.F.

Two stations in the same locality having frequency assignments differing by the amount of the receiver I.F., may combine in the early stages of the receiver, forming a difference beat frequency, equal to the particular I.F. This combination usually occurs when the first tube in the receiver is the mixer stage. It is not uncommon, however, for an undesired I.F. signal to form in an R.F. stage or possibly later in the I.F. stages, when the signals are of sufficient intensity or the later circuits are not completely protected against signal pickup. The presence of an extra I.F. signal, such as brought about by this mixture of local stations, causes a "whistle" or "birdie" to be reproduced when receiving carriers (not related in frequency to interfering signals) over extensive sections of the tuning range. The "birdie" is created by the audible beat resulting from mixture at the second detector of the normal I.F. and the superfluous I.F. signals. The latter is a constant frequency, while the former varies with tuning. Therefore, a variable pitch audio note is produced. Zero beat is obtained at the point of exact tuning.

Discrimination against this type of interference is gained by providing ample selectivity ahead of the receiver stage which is susceptible to the mixing phenomena.

For service, discrimination can be provided at the frequency of one of the interfering signals, preferably the strongest, by use of wavetrap or attenuator circuit, tuned to that particular frequency so as to suppress its strength at the input of the susceptible stage. In applying further practical remedies for this interference, it often is essential to reduce antenna efficiency by decreasing its length or adding a small capacitor (50-200 mmf.) between it and the receiver input antenna terminal. If this

treatment is not effective, back-door points of signal entry, such as under-chassis-wiring, grid leads and power circuits should be investigated. Shielding of the susceptible circuits, and filtering of the power line at the receiver with standard units, may be required. In some cases, each possible point of entry may be contributing a component of interfering signal and each must, there-

fore, be corrected separately before satisfactory performance can be obtained. Re-alignment of the circuits to a higher or lower I.F. will be beneficial. Change of alignment by 10 kc. can usually be accomplished without serious effect on the receiver.

Position leads of radiating receiver to reduce oscillator/antenna coupling. (5) Reduce excitation of radiating oscillator. (6) See that good ground is attached to radiating receiver. (7) Reduce size of antenna used with interfering receiver. (8) Completely shield oscillator stage and filter its supply leads.

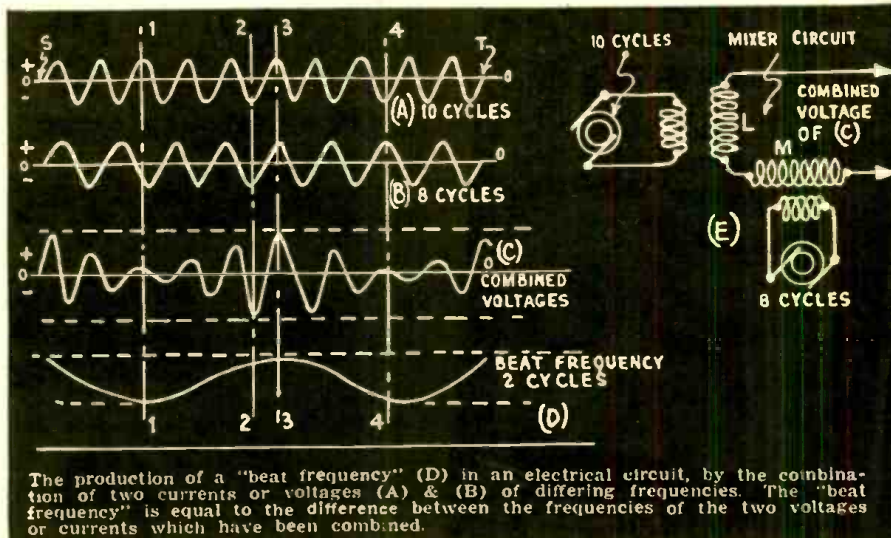

Another illustration showing how a "beat" frequency is produced.

The fact that harmonics of the local stations may subtract with each other or with fundamentals of the same stations, to produce a beat of the nominal I.F., must be considered as possible causes for this type of interference.

VI. HETERODYNE OSCILLATOR RADIATION

The tendency of the oscillator in a superheterodyne to radiate over a limited area occasionally produces interference in another receiver, evidenced as a "whistle" appearing, disappearing and changing frequency at random. This interference becomes prevalent and of consequence in localities where two popular stations are separated by the amount of customarily employed intermediate frequencies (I.F.). For example, in a community having a station "A" at 600 kc. and another "B" at 1060 kc., receivers using a 460 kc. when tuned to "A" will have an oscillator frequency at "B" which will cause interference on

VII. CROSS-MODULATION WITHIN RECEIVER

Two signals are said to be cross-modulated when the program of an undesired station is super-imposed upon the program of the station to which the receiver is tuned. As implied, the secondary modulation is directly associated with the carrier being received, and is not evidenced except when tuned to a carrier. In some cases, more than two or more stations may be causing cross-modulation on another. Occasionally, cross-modulation effects will produce extra responses at random points on the dial, usually showing up as a mixture of two signals and their respective modulations. Cross-modulation may occur on TRF as well as Superheterodyne receivers. Its basic cause is usually related to de-modulation of an abnormally strong signal in the early stages of a receiver, and the tendency to re-modulate on other carriers existent in the same circuits. Non-linearity of the circuit element or tube is, of course, essential to this process. The degree of susceptibility of the first stage to extraneous modulation is a matter of tube and circuit design. Tubes employed in the first stages of modern receivers are of the variable-MU types which have an extended cut-off characteristic, enabling the application of a higher bias for reduction of signal strength, without increasing the susceptibility of the stage to detection or cross-modulation. Selectivity ahead of the first receiver stage goes a long way to avoid the presence of undesired signals on the grid of the first tube. In some receivers extra link circuits are included for this purpose. The amount of cross-modulation varies with the grid bias of the tube and since this bias is a function of the developed automatic volume control voltage,

How "beats" are produced by the combination of slightly different frequencies.

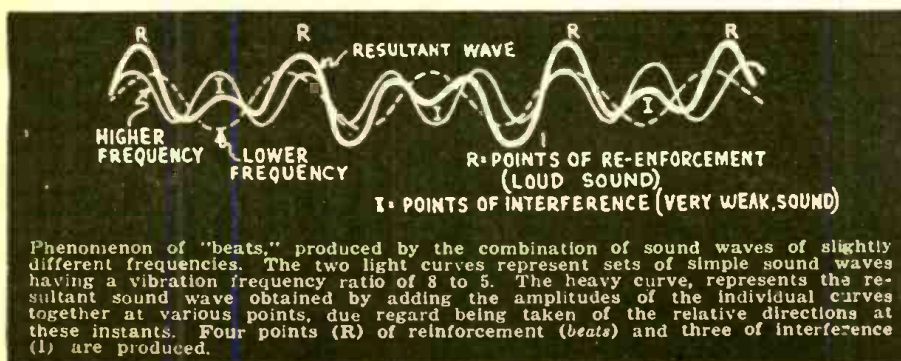

Different Only in Size and Price!

NOW AVAILABLE FOR
FM AND TELEVISION

WESTON

Model 787

UHF Oscillator



Fundamental frequency coverage from 22 to 150 megacycles. No harmonics . . . no band switching. Used with portable antenna or standard output leads. Reads 40 kc per division at 40 mc. Self contained battery operation; compact and extremely portable.

WESTON
Pocket Size
TEST INSTRUMENTS

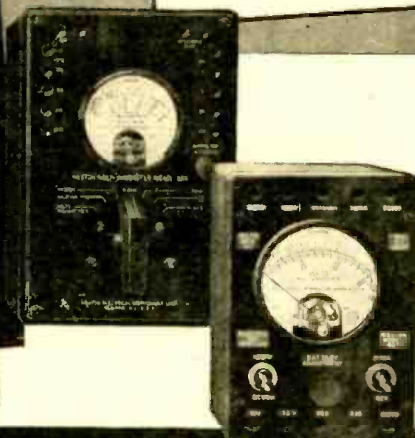

No need to sacrifice dependability when seeking the *convenience* which pocket-size instruments afford. For this series of WESTONS . . . while truly compact in size and low in initial cost . . . provide the dependability and long life which are typically WESTON. In addition, they are versatile instruments; Model 697, for example, providing the necessary voltage, current and resistance ranges for efficient trouble-shooting. Let us send you full particulars on these convenient, low-cost instruments. Write today.

WESTON ELECTRICAL INSTRUMENT CORPORATION
599 FRELINGHUYSEN AVENUE, NEWARK, NEW JERSEY

the cross-modulation is affected by the strength of the input signals.

Where it is necessary to make a service investigation of cross-modulation, the identity of the station causing interference should be established. Where a reasonable amount of selectivity is provided in the head-end of the receiver, an ordinary wavetrap having good attenuation, and tuned to the frequency of the interfering signal, will be effective. It is possible, however, for the abnormal signal to enter the receiver on circuits other than the antenna input. These circuits may be the power line supply, direct pickup on the under-side of the chassis, direct pickup on the grid leads of the receiver, direct pickup on the tubes of the receiver (if not shielded), and in some cases direct pickup either on the chassis or on the ground circuit where this is mutual to an R.F. circuit. A change of the voltage or operating characteristic of the stage affected is not usually beneficial, inasmuch as design determines the optimum point for the minimum of interference. The principal idea to be kept in mind when working on a receiver in an attempt to eliminate cross-modulation, is to protect the susceptible circuits and to reduce the level of the interfering signal voltage.

The importance of filtering the power circuit, having a short low R.F. impedance ground and elimination of ground circuits that are mutual to R.F. circuits, must not be minimized nor overlooked. In many cases, wavetraps will not be sufficient where used singly, but two or more may have to be employed. A parallel-tuned wavetrap in series with the antenna and a series-tuned wavetrap in shunt with the receiver input is the best combination for obtaining the utmost attenuation against an interfering signal.

VIII. CROSS-MODULATION EXTERNAL TO RECEIVER

This type of interference has become prominent in recent years, due to the trend of increase in power ratings of transmitting stations. When two radio waves of sufficient strength encounter any elevated system of electrical conductors in which system there is existent anything that causes partial rectification or detection, numerous new spurious radio frequencies are created which radiate from the system to nearby receiving antennas. When one of these interfering frequencies happens to fall on a desired station frequency, interference results which no receiver can avoid. The interference has no relation to receiver design and will be present on all types including the automotive, battery, A.C. or D.C. It is generally localized in a particular community. The electrical system, whether it be power distribution, telephone system, or other aerial network of conductors and particularly any network or system which is resonant to the local station frequency, can produce this interference if it has a rectifying tendency. Rectification may occur from poor joints or contacts, special nonlinear devices intermittent or poor contacts to earth or to other objects, and rectification due to chemical action at a joint or splice. The neutral or grounding system for power circuits is a frequent cause for generation of this type of interference.

Wherever this trouble develops, it should be definitely identified by checking with various types of receivers, preferably the battery loop antenna type, so as to isolate the source and to determine the limit of the area affected.

Most receivers suppress the 10,000 cycle beat from adjacent carriers either by limitation of fidelity, high degree of selectivity,

or by design of the loud speaker unit to prevent its reproduction of such a note. Filter circuits having sharp cut-off below 10,000 cycles are sometimes provided in high-fidelity receivers for elimination of the beat. A very effective means of accomplishing the same end is through use of a tertiary circuit, consisting of a parallel-tuned coil associated with the loudspeaker matching transformer. This coil is tuned to a frequency slightly below 10,000 cycles and gives a sharply defined attenuation and cut-off of high frequencies.

High-fidelity receivers usually contain a control for reduction of selectivity which makes possible two degrees of fidelity. Where interference from an adjacent channel beat note exists this control may be reduced to effect its elimination. Tone controls also, are normally included on modern receivers and are arranged to reduce the audio response at the higher audio frequencies, including the possible 10,000 cycle interference.

Under ordinary conditions, the ten kilocycle beat is not frequently encountered, since the receivers subject to this interference are usually in the higher-price brackets and elaborate filter protection is justified in the original design. When encountered, however, there are two methods of treatment; the one being suppression of the adjacent channel causing interference with a sharply-tuned wavetrap; and the second, reduction of the high frequency response in the audio system of the receiver. Precise alignment of the receiver may also be beneficial.

When two signals occupy adjacent channels, separated as to carrier frequency by 10 kc., the side-band frequency of one station is very close to the side-band frequency of the adjacent station. If either station is

modulating more than 5 kc. of audio range, the two side bands will overlap. In such a situation, if the side band of one signal enters the second detector stage along with the side band and carrier of the other signal, a peculiar combination of frequencies will result. The most troublesome frequency formed by this combination is that which is produced by the difference between 10 kc. and the modulation frequency involved. For example, if the case is taken where a 3000 cycle note is modulating the adjacent undesired channel, it will produce an interfering side band which will be superimposed upon the desired signal as a 7000 cycle note. That is to say, the side bands of the adjacent channel station form a difference beat against the carrier of the desired station, or the one to which the receiver is tuned. This beat will be in the audible range and will have the character of "inverted speech." This means that modulation on the interfering station of low frequency will create an audible signal of 10 kc. minus this frequency, or a resultant high frequency. High frequency modulation, conversely, produces a low frequency audio signal.

Since this interference is an inversion of the adjacent channel modulation, it appears as an unintelligible mixture, commonly

termed "monkey chatter." Receiver selectivity discriminates against this type of interference. It is also limited by proper restriction of the high frequency audio response. The selectivity ahead of the second detector is, of course, the principal factor in preventing response to the adjacent channel modulation.

"Higher fidelity" receivers are generally the only types affected by "monkey chatter" and their circuits are designed to afford the necessary protection against same. A sharp cut-off filter circuit included in the audio system is common practice in the design of high fidelity instruments. Provision of control for the high frequency end of the audio band and the broadness of I.F. tuning is also common in high fidelity design. Over-modulation of the adjacent channel station accentuates the interference due to "monkey chatter" because of the higher frequency side bands which are generated by such over-modulation. Over-modulation, however, is an unusual condition and should not be investigated as the most prominent cause for this type of interference.

In general, "monkey chatter" interference will be more prevalent at more points on the tuning scale in localities where the number of popular stations is limited, and where such stations are at relatively great distances.

POSSIBLE SOURCES OF INTERFERENCE
Among Stations on New Frequency Allocations

A. IMAGE RESPONSE				D. SECOND HARMONIC OF I-F			
Locality	450 Kc. I-F	455 Kc. I-F	460 Kc. I-F	Locality	900 Kc. 450 Kc. I-F	910 Kc. 455 Kc. I-F	920 Kc. 460 Kc. I-F
Boston, Mass.			WEEI-590 WMEX-1510	Johnson City, Tenn.	Canadian	WJBL	
Charleston, W. Va.		WCHS-180 WCKV-1490		Flint, Mich.		WFDF	
New York City	WEAF-660 WQXR-1560	WMCA-570 WHOM-1480		Carey, Colo.		KFKA	
Omaha, Nebraska	WOW-590 KONB-1490		WCN-WWRL-1600	Oakland, Cal.		KLX	
Syracuse, New York		WSYR-570 WOLF-1490		Denver, Colo.		KPOF	
Spokane, Wash.		KHO-590 KGA-1510		Meridian, Miss.		WCOX	
San Antonio, Texas	KTSA-550 KABC-1450			Sarasota, Fla.		WGBL-WQAN	
				Jessie City, La.		WSUI	
				Richmond, Va.		WRNL	
				Vancouver, Wash.		KVAN	
				Sherman, Texas		KBRV	
				Little Rock, Ark.			KARF
				Sherman, Tex.			KPNF
				Spokane, Wash.			KFPY
				Vernon Hills, Ill.			KUSD
				West Lafayette, Ind.			WBAA
				Atlanta, Ga.			WGST
				Providence, R.I.			WJAR
				Farmington, W. Va.			WMMN
				Visalia, Cal.			KTKC
				Los Angeles, Cal.			KJHJ
				Peoria, Ill.			KSEE
				Buffalo, New York			WBEW
				Frederick, Md.			WFMD
				Jacksonville, Fla.			WJAX
				Oklahoma City, Okla.			WKY
				Quincy, Ill.			WBL
				Paterson, New Jersey			WTAD
				Huntington, W. Va.			WPAT
							WSAZ

B. DIFFERENCE COMBINATIONS		E. SECOND HARMONIC OF BROADCAST STATIONS	
Locality	445-455 Kc. I-F	Locality	Interfering Station
Boston, Mass.	WYAC-580 WBZ-1030	Bangor, Maine	WLBZ-620
Chicago, Illinois	WCFL-1000 WHFC-1450	Knockville, Tenn.	WROL-620
Detroit, Michigan	WWJ-950 WMBC-1400	Los Angeles, Calif.	KFI-640 KMTR-570
Fort Worth, Texas	WBAP-820 KFJZ-1270	Phoenix, Arizona	KTAR-620
Los Angeles, Cal.	KECA-790 KPCC-1240	Chicago, Illinois	WMAQ-670
Minneapolis, Minn.	KMTR-570 KFVD-1020	Washington, D. C.	WMAL-630
NYC-Newark	WABC-880 WBDR-WEVD-1330	New York City	WMCA-570 WEAF-660 WOR-710
Portland, Oregon	WVJ-950 WMBC-1400	Tampa, Florida	WFLA-620
Philadelphia, Penna.	WIP-610 KYW-1060		
San Francisco, Cal.	WFEN-910 WDAS-1400		
Spartanburg, S. C.	KGO-810 KYA-1260		
St. Louis, Missouri	WJZ-770 WORD-1400		
Seattle, Wash.	KOMO-910 KEVR-1400		

F. FUNDAMENTAL (I-F Code only)		
Locality	Call and Frequency	I-F Affected
Brooklyn, N. Y.	WNY-443	450
New Orleans	WNL-448	450 - 455
New London, Conn.	NBL-450	450 - 455
Duluth, Minn.	WDL-454	450 - 455 - 460
Madison Island, Mich.	WID-454	450 - 455 - 460
Rogers City, Mich.	WLC-454	450 - 455 - 460
Cleveland, Ohio	WCY-454	450 - 455 - 460
Alameda, Mich.	WNO-454	450 - 455 - 460
Baltimore, Md.	WVH-454	450 - 455 - 460
Buffalo, N. Y.	WBL-454	450 - 455 - 460
Chicago, Ill.	WGO-454	450 - 455 - 460
Franklin, Mich.	WFK-454	450 - 455 - 460
Ludington, Mich.	WLD-454	450 - 455 - 460
Seattle, Wash.	KSE-460	455 - 460 - 465
Cypress, Cal.	KSM-460	455 - 460 - 465
Edmonds, Wash.	KSA-460	455 - 460 - 465
Musell Rock, Cal.	KTK-460	455 - 460 - 465
Sherwood, Ore.	KCB-460	455 - 460 - 465
Suburban, N. J.	WSC-462	455 - 460 - 465
Aspen, Ore.	NPE-464	455 - 460 - 465
Europe, Cal.	NPE-464	455 - 460 - 465
Key West, Florida	NAR-464	455 - 460 - 465
Norfolk, Va.	NAM-464	455 - 460 - 465
Baltimore, Md.	WTM-468	455 - 460 - 465
Amherst, L. I. (Saville)	WSL-474	455 - 460 - 465

C. SUM COMBINATIONS (I-F does not affect)			
Locality	Station plus	Station gives	Station
Boston, Mass.	WEEI-590	WHDH-830	WAAB-1440
Chicago, Ill.	WMAQ-670	WGN-720	WCES-1390
	WMAQ-670	WBBM-780	WHFC-1450
Kansas City, Mo.	WDAF-810	KMB-980	KITE-1590
New York City	WEAF-660	WJZ-770	WBB-WEVD-1330 +10
	WEAF-660	WNY-830	WCN-WWRL-1490
	WMCA-570	WJZ-770	WBB-WEVD-1330 +10
	WJZ-770	WNY-830	WQXR-1600
	WOR-710	WJZ-770	WCN-WWRL-1490 -10
	WMCA-570	WINS-1000	WHOM-1560 +10
Spokane, Wash.	KHO-590	KFPY-920	KGA-1510

**FOR THE BOOM
IN SERVICING YOU NEED
RCP TEST EQUIPMENT**

Because RCP Test Instruments are engineered ahead and quality-built through and through... because they're lowest priced, you stand to make the most out of the defense boom in servicing with RCP. Increase your service business, customer goodwill and weekly profits—use RCP Test Equipment exclusively. Look at these values!

**RCP-661
ELECTRONIC
MULTI-
TESTER**
DEALER NET
\$36.95



Make complete checking tests on AM, FM and television receivers under actual operating conditions, without disturbing the circuit constants! RCP Model 661 has all the newest, needed ranges, including capacity measurements from .00003 mfd. to 1000 mfd. DC voltmeter impedance 100 megohms or high ranges. 16 megohms on low. AC voltmeter input capacity only .00005 mfd.

VACUUM TUBE DC voltmeter—0/6/30/150/500/1500/6000 V
VACUUM TUBE AC voltmeter—0/6/30/150/600/1500/6000 V
DWMS—0/1000/10,000/100,000/1 meg/100 meg/1000 meg
CAPACITY—0/.001/.01/.1/1/10/100/1000



**RCP-417 APPLIANCE
TESTER AC-DC**
DEALER NET
\$11.95

Measures volts, amperes, watts quickly and accurately. Tests any household electrical appliance, electric signs and industrial equipment up to 6000 watts. Look at all these useful ranges:

VOLTS—0/250 AMPERES—0/1/5/25
WATTS—0/10/120/600/3000 at 120 V.
0/60/240/1200/6000 at 240 V.

Furnished with power-factor classification chart and correction curve for power-factor and line voltage. SEND AT ONCE for new catalog describing the complete RCP Test Instrument line. It's FREE!

**RCP
dependable
TEST
instruments**

RADIO CITY
PRODUCTS COMPANY, INC.
88 PARK PLACE • NEW YORK, N. Y.

**New! HEARING AID
IN KIT FORM**

**EXTRA PROFIT
OPPORTUNITIES FOR ALL
WIDE-AWAKE RADIO SERVICEMEN!**

Opening up a big new volume market for servicemen, this sensational new mid-range hearing aid—the first on the market in kit form—will appeal to men and women alike! Look at these facts: 1. Outperforms 2-tube instruments and has less battery drain. 2. Easily built and serviced. 3. No larger than a pack of cigarettes. 4. Weighs less than most aids. 5. High degree of sensitivity. 6. Small batteries give long service. 7. All components guaranteed. **\$37.50** LIST Complete kit only.

Servicemen and Dealers! Write for Discounts Today!

MICROTUBE LABORATORIES
2412 W. Lawrence Ave. — Chicago, Ill.

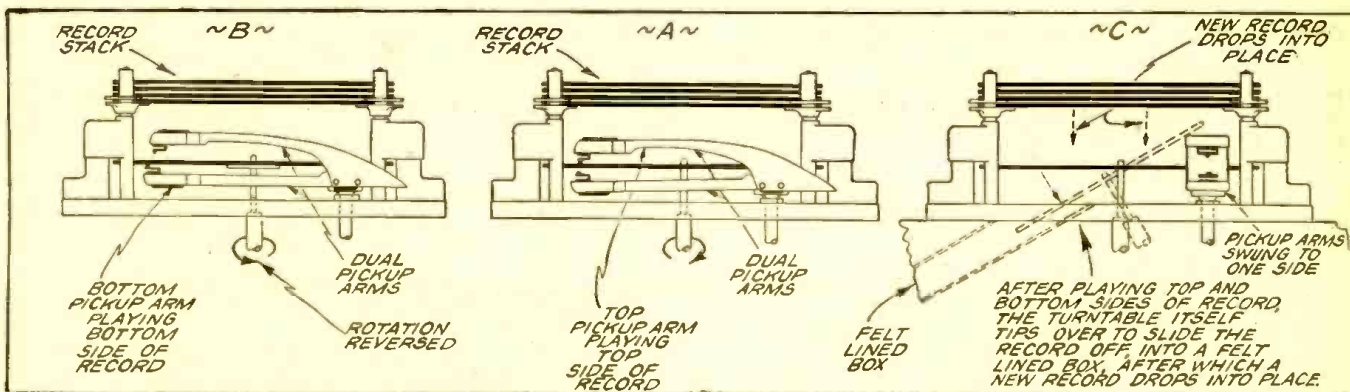

Above—the RCA Automatic Record-Changer in operation: Left—Playing the under side of record: Center—playing the top side: Right—Changing Records.

How It Works!

New RCA Automatic Record-Changer

This remarkable automatic record-changer plays both sides of the record. Either 10- or 12-inch records may be played. The pick-up arm exerts unusually light pressure on the record, thus prolonging its life.

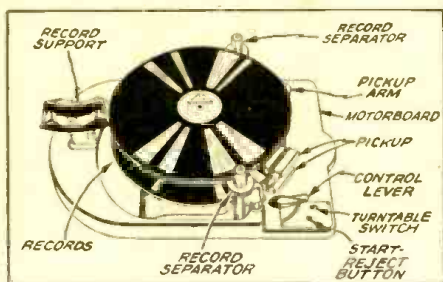

General view of the Automatic Record-Changer, showing control buttons.

A REVOLUTIONARY new phonograph record-changer which will play both sides of a record without turning it over was previewed by music dealers during the 40th Annual Music Merchants Convention recently in New York City.

Demonstrated by its developer, B. R. Carson, RCA Victor design engineer, the new mechanism showed that it will do everything to make life easy for a music lover, except wipe the dinner crumbs from his vest. Labeled "The Magic Brain," the new machine will play an uninterrupted two-hour concert of recorded music without the aid of human hands. It eliminates the necessity of turning records, does away with needle changing, and extends record life indefinitely, according to Mr. Carson.

This revolutionary new type of automatic record-changer plays both sides of phonograph records without turning them over. It is known as the "Magic Brain" with the Tandem Tone Arm, and was perfected in the research laboratory after four years of work. The new instrument provides two hours of uninterrupted music when the starting button is touched. Further, the Magic Brain eliminates the use of old fashioned needles, extends record life indefinitely, and sets a new standard in tone quality for home entertainment instruments.

The Magic Brain is really a combination of several important developments, including the Tandem Tone Arm (shown in the foreground), the Magic Tone Cell (the pickup cartridge), the Flexible Tone Bridge

and the Jewel-Lite Scanner (replacing the needle). It is only necessary to stack the records on the automatic mechanism and press the starting button.

The Tandem Tone Arm, which is actually two arms and two pickups, swings over automatically and plays the top side of the bottom record of the stack (there is no record on the turntable in this photo in order to show the mechanism more clearly) which has been dropped to the small turntable. After reaching the end of the record, the Tandem Tone Arm swings clear of the record while the direction of the turntable's revolution is reversed. Then it rises far enough to make contact with the bottom side of the record. When the underside has been played, the Tandem Tone Arm swings away so that the record may be deposited gently into a felt-lined compartment (through the opening shown to the left), after which another record from the bottom of the stack drops into place. The cycle is repeated until all the records (in any number up to 15) have been played. The Magic Brain then automatically shuts off. Records in any sequence, manual, automatic mechanism, or drop mechanism, may be played.

The controls of the Magic Brain are exceedingly simple. The large lever above the hand in the picture adjusts the mechanism for playing either one or both sides of the records. A record may be rejected while playing by pushing the starting button. An on-off switch is the only other control on

the panel. To adjust the drop mechanism for 10- or 12-inch records, it is only necessary to turn the support shown to the far left.

TECHNICAL DETAILS

The RP-151 is an automatic record changer of revolutionary design. It will play a series of fifteen 10-inch or twelve 12-inch records on both sides, or one side, at will. The pickup arm has two light-pressure, sapphire permanent-point, crystal pickups mounted on one arm. One pickup plays the top side of each record; the other pickup plays the bottom side. The turntable rotates in reverse while the bottom side of a record is being played.

The mechanism has two motors. One motor is used solely to rotate the turntable; the cycling motor drives the mechanism during the automatic record-changing cycle.

There are three simple controls.

1. *A Record Support*—Turn it one way to load a stack of 10-inch records, the reverse way to load 12-inch records.

2. *A Control Lever*—Push the lever to load position, then back to the "two-side" position to play both sides of each record; pull it forward to play only the top side of each record.

3. *A "Start-Reject" Button*—Push the button to start the mechanism or to reject a record when the mechanism is operating.

The device uses a low-noise crystal pickup. This article prepared from data supplied through the courtesy of RCA Mfg. Co.

Wiring diagram of the RCA Automatic Record-Changer.

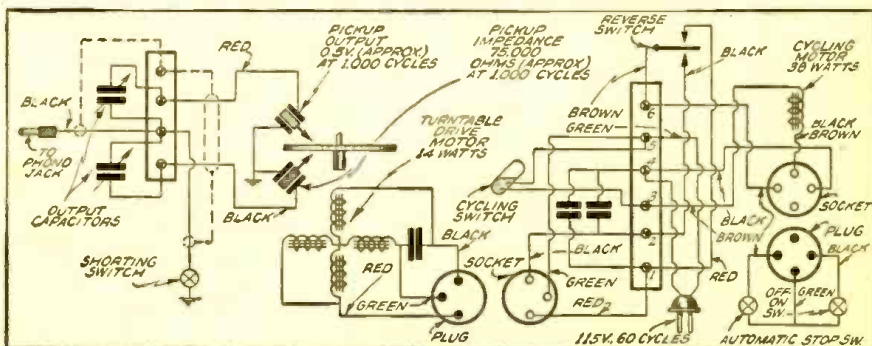

At your service . . .

PRICES?

No matter what happens to prices—here at Harrison our large scale purchasing and our tremendous stock enable us to continue to give you the lowest possible prices at all times.

It pays to buy from Harrison!

DELIVERY?

With production facilities already greatly overtaxed, deliveries are falling behind more every day. But, we anticipated this "Back-order Era" and placed protective orders many months ahead.

Right now we have more receivers, parts, tubes, etc., on hand than at any time in our busy sixteen year history!

You get faster delivery from Harrison!

TRIAL?

When you buy anything from Harrison it has to be entirely satisfactory or you don't keep it. Try out your next receiver for ten days without charge or obligation by ordering it from us.

You get 100% cooperation from Harrison!

TRADE-IN?

By fair dealing we have built up the largest Reconditioned Receiver business in the world! We have a ready market for your old set, and that means we can give you the very best trade-in allowance. (We also buy receivers, transmitters, etc., for cash.)

You get the best deal at Harrison!

TERMS?

Certainly! Charge Account or Easy Payment Plan. Buy your Receiver, transmitter, parts, etc., on our easier terms at lowest cost.

Your credit is good at Harrison!

GUARANTEE?

Everything is "guaranteed," but your best guarantee is the integrity of the person with whom you deal. Here at Harrison we go far beyond the standard warranty in order to please you!

You get a square deal from Harrison!

I'll be looking for your order!

73,

BILL HARRISON, W2AVA

(Send for my latest list of New and Reconditioned Receivers)



hallicrafters Super Skyrider

Model SX-28. "Tops" in performance. 15 tubes, 2 r.f. stages, calibrated bandspread, etc. Covers .55 to 42 mc.

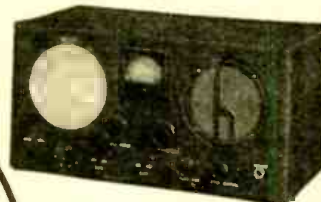

hallicrafters Sky Buddy

Model S-19-R. A six tuber that offers good results for a moderate price. .545 to 44 mc with continuous electrical bandspread.



hallicrafters Super Defiant

Model SX-25. Has all the features of sets selling for nearly twice as much!



hallicrafters Sky Champion

Model S-20-R. Excellent value. Nine tubes, noise limiter, preselector stage. .545 to 44 mc. bandspread, etc. Socket for battery or vibro-pack operation.



hallicrafters Sky Traveler

Model S-29. You can take it with you! Works on self contained batteries or any AC or DC line. Built-in telescoping antenna. 9 tubes. .542 to 30.5 mc. bandspread. internal speaker, battery recharger.

It's **HARRISON** *for*
hallicrafters and SERVICE!

HARRISON RADIO COMPANY 11 West Broadway, New York City
Worth 2-6276

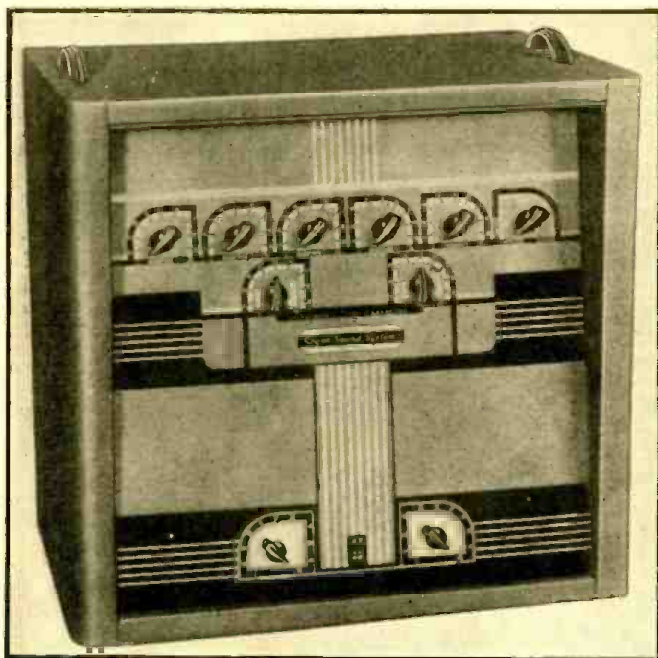

Appearance of the 70-watt amplifier.

70-Watt Flexible Amplifier

This amplifier is an unusually flexible 70-watt unit and it has five input channels. It has a Compressor-Expander-triple-range Tone-Control—and two complete 35-watt Amplifier Channels, with a separate power-supply for each power amplifier channel. Remote control circuits are "built-in" for all channels. The amplifier also features new straight-line expansion.

AN unusual high-power amplifier, embodying highly desirable features for public-address use, is the Model EX70 amplifier.

Briefly, the unit provides for four microphone and one phonograph inputs, with compression for microphone use and expansion on record reproduction. A unique *tone-corrector* circuit enables the frequency response to be varied in three separate bands: high register, middle register and bass. The normal output of 70 watts is obtained from two separate 35 watt channels, each with its own power-supply.

MIXING AND FADING SCHEME

The four microphone inputs each feed into a 6SF5 tube, which in turn feed into a single 6SF5 tube through a mixing and fading arrangement. As is shown in the schematic, the 250,000 ohm resistors in each volume control circuit prevent interaction at different control settings. The phonograph feeds into a 6SF5 tube with volume control in the grid circuit, the output of which feeds into the third stage, a 6SJ7 tube.

Remote control operation is obtained by varying the plate voltage on the input stages, isolating networks preventing shorting B plus when any one remote control is turned down. The standard remote controller available for this model controls only two inputs, so that a changeover strip is provided to make any of the five available for remote control. The remote volume controls are special taper megohm rheostats. Obviously, the phonograph channel utilizes a separate tube, instead of operating into the second stage through a volume control, in order to permit remote operation. This type of remote control is free from hum pickup and remote lines may be run several thousand feet, also not affecting frequency response.

TONE-CORRECTOR CIRCUIT

The output of the third stage feeds into the Tone-Corrector circuit, which is purely resistor-capacitive, using no inductive parts. The advantages for this type of circuit are greater uniformity—due to easily controlled circuit constants—thus lending itself to mass production methods; and the freedom from hum pickup prevalent in using inductive components in high gain circuits.

The tone corrector employs two variable

controls—one for bass, one for treble. With the two controls in the *middle* or *normal* position, the amplifier has a flat response. Referring to the schematic diagram of this circuit, the treble control, a center-tapped one-megohm potentiometer, places the .0005 mf. condenser across the series half to give high frequency compensation, or across the lower half to shunt them. The degree of rise or shunt of the treble is controlled by the resistance in combination with the condenser at any given setting. It can be seen that in the normal position the .0005 mf. condenser is shorted. This treble control gives a 12 db. rise or an attenuation of 25 db. at 10,000 cycles.

The bass control is a dual type, each section being two megohms total resistance. Increasing the resistance across the .03 mf. condenser results in a bass boost; increasing the resistance across the .003 mf. condenser, results in bass attenuation. It can be seen that with a high resistance across the .03 mf. condenser, or full on of the bass control, the result is a bass compensation network, whereas full off, or high resistance across the .003 mf. condenser constitutes a series capacitance or bass attenuation circuit. Each section of this dual control is effective over only half of its rotation, with a short over the other half, so that bass boost is independent of bass cut. In the normal position both condensers are shorted. This control gives a rise of 19 db. or attenuation of 25 db. at 30 cycles.

In this way the response of the amplifier is divided into three bands: bass, or 30 to 400 cycles, controlled by the Bass control; Treble or 2,000 to 10,000 cycles, controlled by the Treble control; and the middle register, controlled by the Volume control.

COMPRESSOR-EXPANDER FEATURE

The schematic of the compressor-expander circuit is indicated in dotted lines. The microphone signal is picked off from the output of the second stage and fed to one of the two triodes of the 6SC7 tube. This in turn is rectified by one section of the 6H6 to obtain the negative bias for the 6SA7 variable mu tube. This tube is normally biased at 8.4 volts. On full compression this bias may be increased to 14 volts.

The phonograph signal is picked off at the phonograph control and fed to the second

triode section of the 6SC7 tube. This is rectified by the 6H6 tube to obtain the negative bias to control the 6SA7 tube. On full expansion the bias may become three volts. The compressor-expander control is in the form of a center-tapped one megohm potentiometer, allowing for normal in the center, *compression* in any desired degree to the left, and *expansion* to the right.

The circuit has been carefully designed to prevent cutoff in compression, and to provide expansion so that soft passages of symphony records are not affected, whereas expansion of 12 db. is provided on loud passages, subject to the position of the control.

The output of the 6SA7 tube is connected to a receptacle to permit coupling to the lower chassis.

The input to the power section is fed into two controls, to form two separate power amplifiers. Each consists of a 6C5 tube, resistance coupled to a 6F6G tube, which is transformer coupled to a pair of 6L6G tubes in pushpull. Feedback in each channel is obtained by coupling the output back to the driver grid through an appropriate network.

The output is available on terminal strips mounted on the rear of the chassis, one for each output amplifier and provides for impedances of 4, 8, 15, 250 and 500 ohms.

Each power output section has its own power-supply, a 5X4G supplying the B voltage and a 5W4 the separate bias supply.

The B supply for the upper chassis is obtained from the two power-supplies, so arranged that if one fails the other will supply it.

The arrangement of this amplifier makes it possible to use it either as two separate units, each feeding a number of speakers, or they may both be combined to form a single high-power amplifier. In addition, a modified binaural effect may be obtained by connecting a speaker to each output channel and placing these speakers at either side of a stage. By manipulating the power channel controls sound can be made to "move" across the stage. When used with microphones this feature is particularly striking, as sound following the action can be made more realistic as it moves from one side of the stage to the other.

This article prepared from data supplied by courtesy of the David Bogen Co.

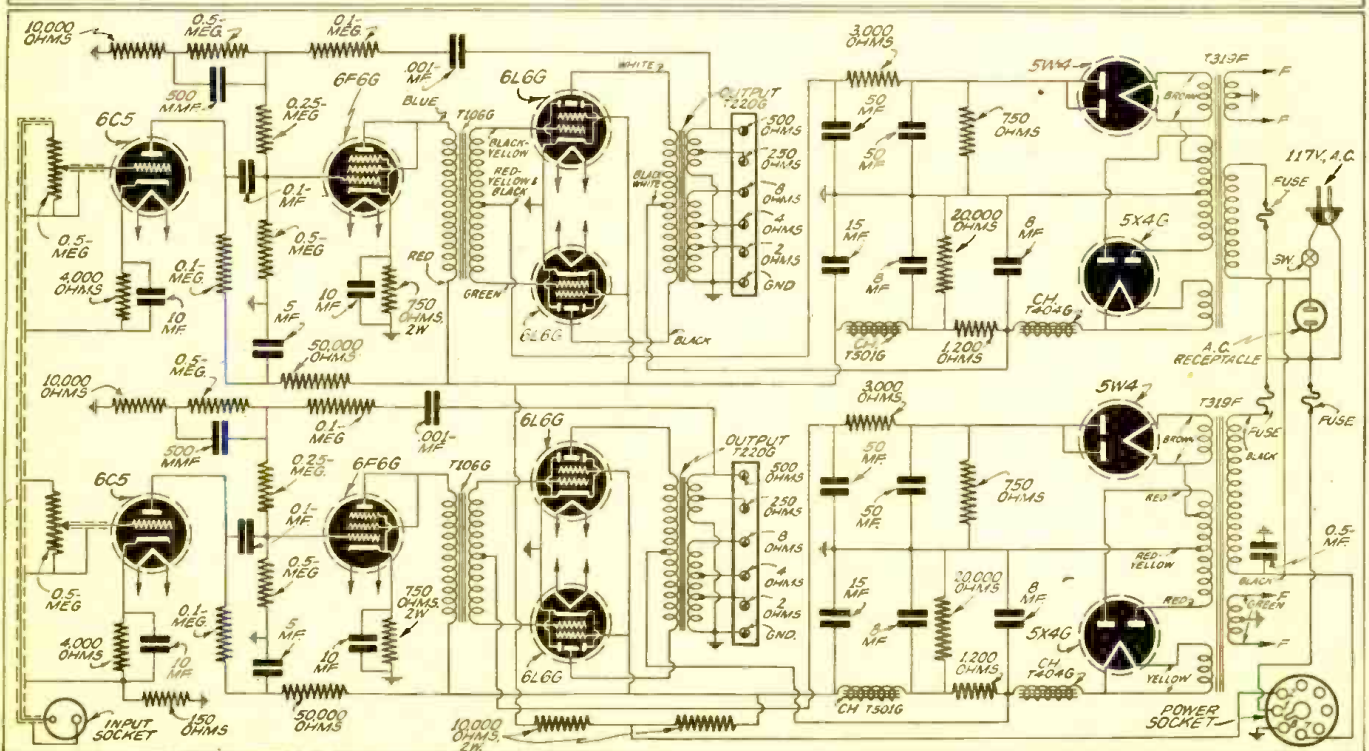
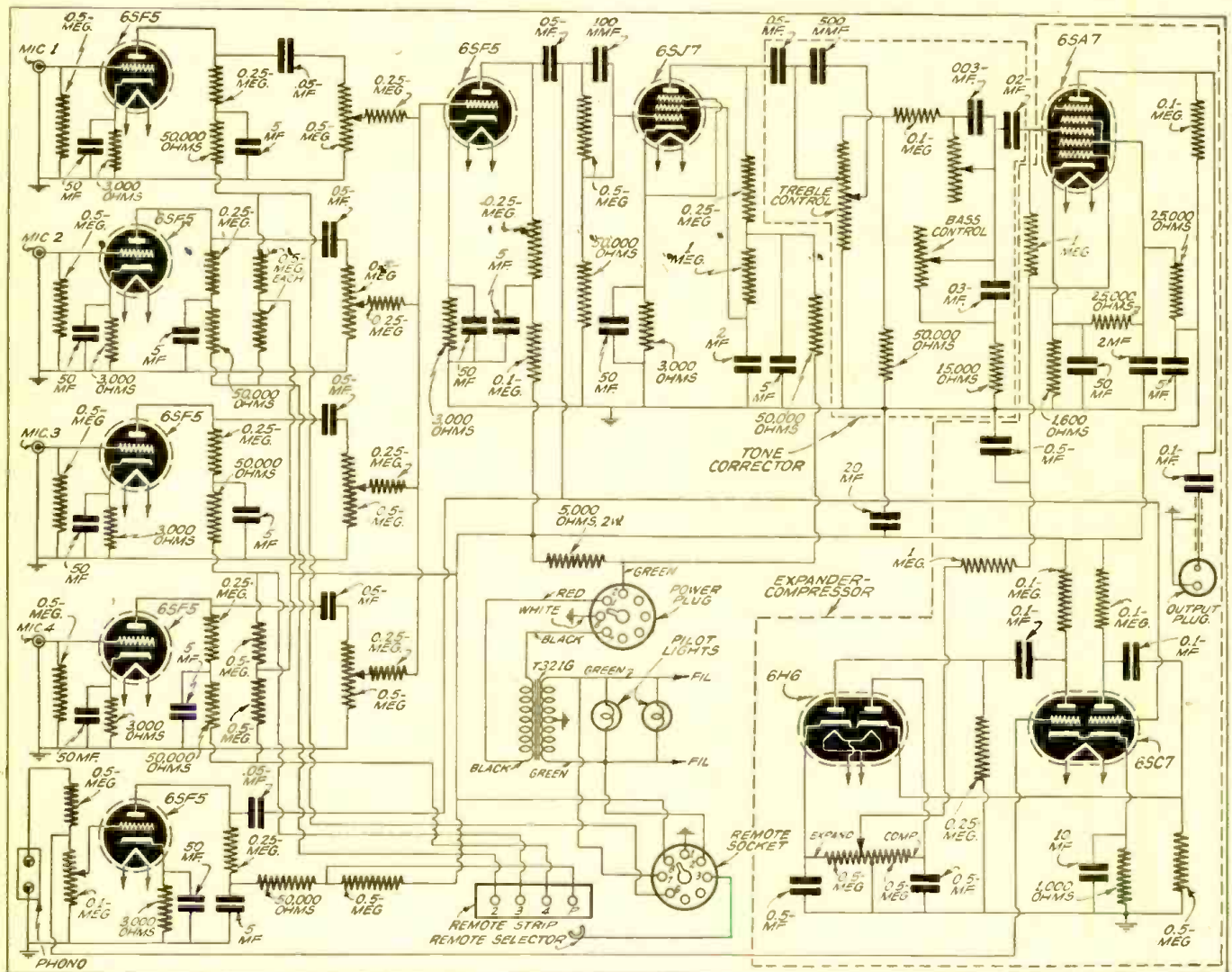

Diagram of the 70-watt Amplifier, together with diagram of power-supply and bias rectifier hook-up. It features tone-correction, bass control, compressor-expander (indicated by dotted lines), and two complete 35-watt amplifier channels.

How to Sell

SCHOOL SOUND SYSTEMS

B. E. PHILIPPSEN

The selling of P.A. sound systems to schools and colleges is a science today. In the accompanying article Mr. Philippsen gives some clear advice on "How to Approach School Supervisory Boards," "How to Close the Sale," and just what features should be emphasized in each step of the transaction.



The P.A. Sound System is today an extremely valuable asset to every large school in the country. This application of sound amplifier apparatus represents a very fertile field for every Serviceman.

It is surprising to note that the "How and Wherefore" of *School Sound System* selling today still looms as a question mark in the minds of many Servicemen-Dealers. The average serviceman has looked too long on most jobs as a "one-two" deal. In radio service, where the serviceman is dependent on his income from a large number of individual jobs, this is undoubtedly the most efficient way to render customer service and still be able to show a profit.

Selling *School Sound Systems* is not a "one-two" job. On the contrary, it is more likely to be a protracted business deal, with the grand prize awarded to the best man. Most of us prefer to widen our basic knowledge of associated enterprises. Selling *School Sound Systems* places demands on a type of technical salesman for which the serviceman, with certain easily acquired qualifications, is ideally adapted. In this article are presented the essentials for successful selling, divided into the following condensed headings.

The Clue
The Contact
The Bidding
The Closing

This article should prove of special interest to both servicemen and service-dealers because it presents still another form of net income and tells how to go about getting it in the simplest straight-forward manner. While servicemen-dealers today sell a profit-boosting line of broadcast receivers, there is still adequate room and

reason for adding other means of additional income. The field of *Sound* amplifiers, as such a means, is so wide in its scope that to explain such a selling job in its entirety, would require a book length text. With an aim to provide a general background to the selling of *Sound Systems*, this article therefore concerns itself mainly with *School Sound Systems*. Of course, it follows that many of the suggestions can likewise be applied to other *Sound* selling jobs of lesser or greater importance.

THE CLUE

There are forever among us, known or unknown to us, clues—or opportunities. The "live wire" businessman sees them, goes out after them and snares them. Opportunities rarely walk into your store. So it is with *School Sound Systems*. As the head of a school, the principal in all probability has little reason to know you are in business. He does get to know about you as you contact him—that *IS* your business. Should you, knowing that a given school is not equipped with sound, approach that principal out of a blue sky, as it were, and start talking sound to him? By all means, *yes!* Do it with all the possible enthusiasm that you can muster but with the least possible anticipation of an immediate sale. Because of the very nature of the transaction and conditions involved, the instantaneous sale, even though the principal is favorably inclined, is out of the question.

How can you find schools which are

possible prospects for a sound installation? There are various methods. The simplest is the daily newspaper. Watch for announcements of contracts let for new school buildings, announcements that bids are in order for the addition of a new wing to the school building, etc. Of course word-of-mouth information, if known to be reliable, is definitely faster and more valuable. If one contractor has already won the bidding, see him immediately, find out if he is sub-letting the sound system installation, if any has been included in the specifications.

Other good sources of information are the monthly building contractors' magazines. Subscriptions to these are worthwhile, but not essential if copies are obtainable at your public library. Visit your library first, select the one magazine with the greatest emphasis on listing new contracts in your part of the country. Do not expect to see five to ten new buildings listed for your area. There may be just that many listed for the entire middle west, east or west coast.

The third source of information is the bulletin board found in most local courthouses, city or town halls. Here are posted the dates for new bids on most municipal buildings including public schools and school additions.

As mentioned above, blindly approaching a school principal on the subject of a sound system is recommended not for the purpose of an immediate sale but for the purpose of either planting the germ of an idea or giving growth to that germ. In addition, he now knows you, a valuable stepping stone to further the relationship which eventually grows and provides you with an advantage over your competitor.

THE CONTACT

Whether you approach a contractor or school principal, let certain principles guide your manner and presentation. Remember first and foremost, that technical language, as it is spoken by two radio men in conversation, is definitely out of the selling picture. Your prospect, the school principal, and the school board are human beings whose conversational knowledge of sound systems extends no further than "loud-speaker" or "microphone system." It is the common fault of many servicemen to willingly or unknowingly, impress on the average layman their superior knowledge by the use of high-sounding technical terms and phrases. Such improper use of words otherwise useful in the industry, has no place in the approach to a successful selling venture. Should the principal, school board member, or physics instructor volunteer a question requiring a technical answer, it is just good common sense for the serviceman-dealer to boil it down to pure and simple essentials. Truly enough, the very same answer you give to the unknowing layman can be ridiculed to high heaven by those of your

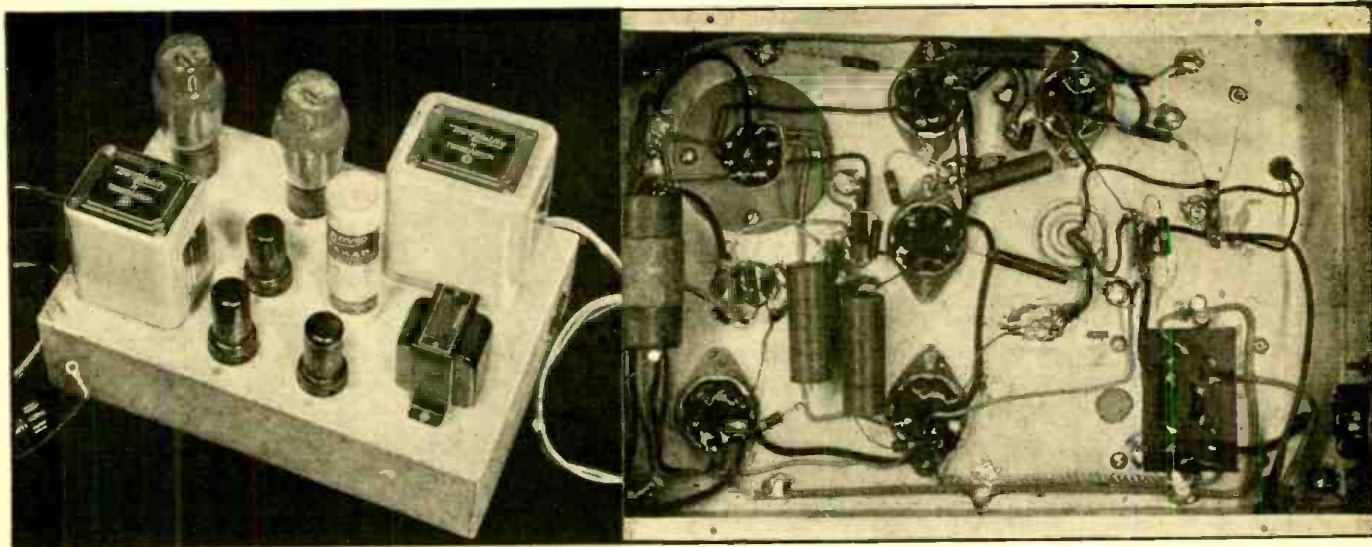

General view at left—bottom view at right.

A "HIGH QUALITY" AMPLIFIER

EMILE J. ROME

IN this article and its accompanying photographs and diagrams can be seen the results of the writer's endeavor to create an amplifier ideally suited for the reproduction of musical programs, such as radio broadcasts and recordings, with a high degree of realism. The amplifier had to be more than just ordinarily good as its ultimate purpose was to please the discriminating music lover.

After much experimenting with various types of resistance-coupled and transformer-coupled circuits, the circuit described herein was finally arrived at as filling this exacting requirement.

In the tube line-up, triodes are used throughout with the exception of the output stage which uses 6L6Gs in push-pull, with inverse feed-back.

Thordarson Tru-fidelity audio transformers are used in the interstage and output stage and are largely responsible for the excellent results of which this amplifier is capable. These transformers have a frequency response of plus or minus 1/2 decibel from 30 to 15,000 cycles per second and have hum-buck construction, with heavy iron cases. The over-all gain of the amplifier is approximately 75 decibels. Power output is 15 watts at less than 2% distortion, although higher output is possible with an increase in distortion content. Let it be mentioned at this point that high power output was not considered an essential factor during design; medium power output, with excellent fidelity, was the keynote. However, an output up to fifteen watts provides an adequate reserve for the handling of loud signal passages without noticeable distortion.

While this amplifier is inherently simple, it incorporates certain features well worthy of consideration: For instance, the direct coupling of the first audio stage with the phase inverter tube is an innovation in itself and is deserving of comment and will be discussed at length later in the text.

FIRST AUDIO STAGE

The first audio stage is a 6J5, self-biased, with no condenser from cathode to ground so as to take advantage of the small amount of degeneration occurring in the 2500 ohm bias resistor. The grid of this stage receives

This excellent audio amplifier has a power output of 15 watts at less than 2% distortion. The over-all gain of the amplifier is 75 decibels.

its signal from the volume control which is connected to a phono-radio switch. A high-frequency tone control, consisting of a .02 mf. condenser and a 150,000 ohm potentiometer, is connected from plate to ground of the 6J5. This tone control was incorporated for the purpose of attenuating high-frequency extraneous sounds and hiss from broadcast programs, when there is a predominance of such sounds, and for reducing surface noise (needle scratch) when playing worn phonograph records. Otherwise, use of the tone control is not recommended as it only defeats that which so much energy was exerted to attain—a flat output curve with extended high frequency response. The first audio stage is further discussed with the phase inverter as it is closely related to that stage because of the direct coupling employed.

Following the phase inverter is a stage of push-pull 6J5s. Push-pull at this point was considered desirable for the elimination of second harmonic distortion at high signal levels. Also, while the grids of the output stage are never operated positively, the use of feed-back doubles the signal voltage required of the driver stage. A Thordarson Tru-fidelity transformer couples this stage to the output stage.

PUSH-PULL, BEAM POWER OUTPUT STAGE

Two 6L6Gs, in push-pull arrangement, are utilized in the output stage, with 16 2/3% inverse feed-back. This amount of feed-back was decided upon in order to reduce speaker resonance (boom) and distortion to an absolute minimum and to flatten the frequency response of the output stage. This stage is coupled to the speaker voice coil by means of a Thordarson Tru-fidelity output transformer. The primary of this transformer is rated at 5000 ohms with appropriate taps for matching the speaker voice coil. However, inasmuch as the 6L6G output stage requires a load of 6600 ohms for proper operation, its rated impedances of the secondary taps had to be disregarded and a selection of taps for reflecting the

proper impedance from the speaker voice coil to the plates of the 6L6Gs had to be made. The following formula is applicable in this instance:

$$Z_x = \frac{L^1 Z}{L^2}$$

Where L^1 is the transformer primary rating.

L^2 is the proper load for the tubes used.

Z is the voice coil impedance of the speaker used.

Z_x is the impedance of the taps necessary to effect a match.

Thus, with a voice coil impedance of 10 ohms and a required plate load of 6600 ohms, we have,

$$Z_x = \frac{5000 \quad 10}{6600} = 7.5 \text{ ohms.}$$

By connecting the 10 ohm voice coil to the 7.5 ohm taps of the output transformer secondary, a proper match is accomplished for the 6600 primary requirement. A way to check this is by determining the correct impedance ratio. For instance, with a 6600 ohm plate load and a 10 ohm voice coil, the impedance ratio is

$$\frac{6600}{10} = 660,$$

practically the same as with a 5000 ohm plate load and a 7.5 ohm voice coil.

The output stage is flexible in that low-mu triodes (2A3s or any of their 6.3 volt counterparts) may be used instead of 6L6s, in applications where it is desirable to have a low plate resistance output stage, such as working into a recorder cutter-head, etc. Or, where greater output is needed, parallel push-pull 6L6Gs (AB¹) can be used. These changes in the output stage are possible without effecting the phase inverter stage or push-pull interstage, thereby retaining their features. Of course, the greater current drain of a parallel push-pull output stage will have to be taken into

the 1941 Communications Value!



The Sky Champion represents one of the best values ever offered in the communications field—has all the essential controls for good amateur reception. 9 tubes, 4 bands, tunes from 545 kc. to 44 mc. Band one 545 kc. to 1720 kc. Band two 1760 mc. to 5.2 mc. Band three 5.3 mc. to 15.6 mc. Band four 15.3 mc. to 44 mc. Automatic noise limiter. AVC switch. Standby switch. Inertia bandsread tuning. Separate electrical bandsread. Beat frequency oscillator. Battery-Vibrapack, DC operation socket. Cabinet dimensions 18½" long, 8½" high, 9¾" deep. The Sky Champion (Model S-20R) \$54.50.

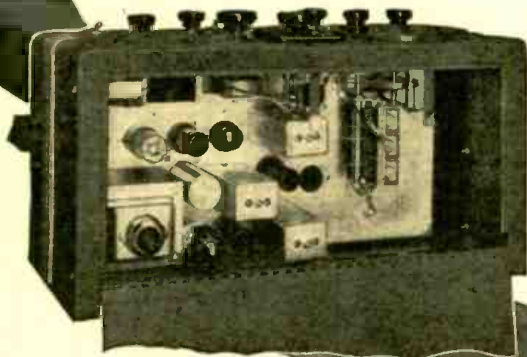

Tube line-up, 6SK7 RF amplifier, 6K8 first detector—mixer H.F. Oscillator, 6SK7 first IF amplifier, 6SK7 second IF amplifier, 6SQ7 second detector, AVC first stage of audio, 6F6C second audio output stage, 6H6 automatic noise limiter, 6J5GT beat frequency oscillator, 80 rectifier.

the hallicrafters co.
CHICAGO, U. S. A.

USED BY 34 GOVERNMENTS • SOLD IN 89 COUNTRIES

SPECIAL NOTE

To wide-awake
Dealer-Servicemen
 Your Golden Opportunity
 is **RIGHT NOW!**



Push the Meissner
F-M CONVERTER
 For **EXTRA PROFITS!**

Now is the time to cash in on Converter sales—before the sale of new set models with built-in F-M has a telling effect! The Meissner F-M Converter, conveniently connected to ANY radio set, gives the same performance at a third of the cost. Take one under your arm when you call on a service customer—demonstrate the amazing quality of this new system—leave it on trial if you can't walk away with a check! The radio public is rapidly becoming F-M minded—new stations are going up at a rapidly increasing rate—and they're going to demand F-M in a hurry! The best, simplest and most economical way is by using the Meissner F-M Converter with the present radio set. But **PUSH IT NOW!**

F-M CONVERTER, Complete with tubes, Model 9-1047A. List Price . . . \$44.95

INSTRUCTION MANUAL
 1941 EDITION

Get your copy of this big new manual at once! 168 pages, 8½ by 11 inches, full of all the latest in receiver circuits, complete instructions on all Meissner kits and wired sets. Many pages of data on F-M; coil design, charts and tables.

Only 50 cents Net

Write for Free Complete Catalog!
 Dept. C-12



New Station WABC on Columbia Island, New York

The transmitting equipment for the new Station WABC (opened officially Oct. 18th) on Columbia Island in Long Island Sound was designed and manufactured to CBS specifications by the Federal Telegraph unit of International Telephone & Radio Manufacturing Corporation, manufacturing subsidiary of International Telephone and Telegraph Corporation.

There are two complete and independent transmitters, the main broadcasting unit capable of delivering 50 Kw. 100 per cent modulated, and an auxiliary transmitter of 5 Kw. which would go into service immediately should anything cause the main transmitter to fail and thus assure continuous service under any conceivable conditions.

The water-cooled vacuum tubes, each with an anode dissipation rating of 40 Kw. are employed in the final radio frequency amplifier. The two tubes are capable of providing a 50 Kw. carrier and, at 100 per cent modulation, they deliver the necessary 200 Kw. peak power. The filaments are A.C. heated, thus avoiding rotating machinery and additional maintenance.

Because of the situation of the station on tiny Columbia Island, all frames, panels and component parts of the transmitters have been specially finished against any corrosive effects of salt air.

The auxiliary transmitter is air cooled as insurance against any failure of water supply.

An additional feature is provided to safeguard continuity of operation at 50 Kw. The 5 Kw. auxiliary unit can be used to provide driving power to the high power output amplifier in case trouble develops in the low power stages of the main transmitter.

Certain portions of the equipment, principally the radio frequency oscillator and its associated low power amplifiers and the low level audio amplifiers, are provided in duplicate for both the main and auxiliary transmitters. This additional apparatus further insures continuity of service and simplifies the job of equipment maintenance. Each unit is complete with its individual power supply and is so arranged that the unit not in operation may be readily removed from the transmitter for maintenance.

Because of the many automatic features, the control system is one of the most ingenious ever provided for radio broadcasting. All operating controls and indicator signals are centered at the control console.

To assist airliners bound to and from LaGuardia Field, the height of the tower was kept to 410 feet above mean sea level, with an 85-foot circular steel ring horizontally-centered at the top.

If power from the land should fail entirely, there is an auxiliary gasoline-driven generator that can be switched in with a time lag of only three seconds.

For bringing programs to the transmitter, there are two sub-sea transmission lines, each containing seven pairs of wires. They, too, are armored by layers of steel wire wrapping, and are designed to withstand the ravages of the sea.

If one of them should be cut by a ship's anchor or other accident, the other would be used. If both should fail through some unforeseen disaster, there is an emergency cable fixed to a drum that can be unreeled from a boat and hooked up to the shore terminal.

If all these should fail, there is, still an ultra-high frequency transmitting and receiving system linking the island and Columbia's studios in New York.

NEW AUDIOGRAPH Sound Catalog

AUDIOGRAPH Sound Systems represent the latest in Sound Engineering and Design—a complete line plus pre-tested accessories.

NEW LOWER PRICES
 Outstanding quality and performance at prices that help you meet any competition.

WRITE FOR FREE COPY
JOHN MECK INDUSTRIES
 1313 W. Randolph St. Chicago, Ill.

BIG FREE CATALOG

EVERYTHING IN RADIO

Sets, parts, supplies, public address systems, amateur equipment, testers, kits and fluorescent lighting at lowest prices. Huge stocks, bought months ago . . . ready for shipment the same day your order is received. The Defense Program is making big demands on our industry but because of our advance buying we are able to fill your orders promptly and efficiently.

BURSTEIN-APPLEBEE COMPANY
 1012-14 McGehee, KANSAS CITY, MO.

RADIO CATALOG NO. 58
 164 PAGES
 SETS-PARTS
 SUPPLIES
 FLUORESCENT

Burstein Applebee Co.

WHAT STRANGE POWERS
 Did The Ancients Possess?

WHERE was the source of knowledge that made it possible for the ancients to perform miracles? These wise men of the past knew the mysteries of life and personal power. This wisdom is not lost—it is withheld from the masses. It is offered freely TO YOU, if you have an open mind. Write for free sealed book. Address: Q.P.F.

The ROSICRUCIANS
 San Jose (AMORC) California

GOLDENTONE . . . 50% OFF

DEAL DIRECT FACTORY PRICES.

Over 75 models to choose from—4 to 12 tubes. Portables \$8.98 up. Farm sets \$8.98 up. Car sets \$8.98 up. Foreign band sets \$8.98 up. Samples 50% off. Quantity discounts. Free 1942 Barren catalog gives details of 10-day FREE trial. Agent's proposition and discounts. No obligation. Mail postcard to:

GOLDENTONE RADIO CO., DEPT. RC, DEARBORN, MICH.

49¢ CASH READY TO PAY
 YEAR GUARANTEE

Free Catalog of RCA RECORDS

WANTED

Electronic-research vacuum tube engineer having experience on design of Magnatrons and velocity modulated tubes and associated circuits. Also wanted, vacuum-tube development engineer having experience on design and manufacture of high power transmitting vacuum tubes. Another mechanic needed having experience in the assembly of high-power vacuum tubes familiar with spot welding and arc welding operations.

INT. TEL. & RADIO LABS.
 67 Broad St., 2nd Floor, New York City

FREE! RADOLEK'S BIG RADIO PROFIT GUIDE

Everything New In Radio at Bargain Prices! Radio parts—Sets—Accessories—Ham gear—Electric appliances and vacuums—Public Address Systems. Don't Walk—Send for the Big FREE Radolek Profit Guide Now! Save Money at Radolek.

RADOLEK CO., Dept. C-60
 601 W. Randolph St., Chicago, Ill.

HIGH EFFICIENCY!
 University Reflex Speakers will project sound clearly for two miles with less than 25 watts input. Write for catalogue.

UNIVERSITY LABORATORIES
 195 Chrystie St. New York City

Type of Service Manual!

CIRCUIT MANUAL—1941

MORE INFORMATION IN HALF THE NUMBER OF PAGES

The value of a service manual is measured not by the number of pages but by the amount of useful information. Thus, in only 736 pages this Radio Circuit Manual covers over 200 receiver models MORE than does any other competitive manual in twice the number of pages.

HOW DID WE DO IT?

By increasing the size of our page; by discarding non-essential data and editing the balance; by listing only those

receivers which the Service Engineer will definitely have to repair (no communications or export receivers, no shortwave sets or amplifiers, no electronic devices, etc.); by many months of hard work based on a definite plan of procedure and a clear understanding of the actual requirements of the Service Engineer. There is no "dead weight" information to add bulk to this Manual. Every word counts. Every minute of reading time is well spent.

RES

age permits listing
tion on one page.
voidable cases ex-

r all superhet cir-
ddly displayed in
—none missing, all

ted on communica-
ort receivers, am-
ronic musical in-
—a 100% Serv-
Manual.

MANUAL IS

vice Engineer. In-
ve been in the past,
ial radio diagrams
the maximum con-
ial data have been
rapid and efficient
easy-reading style
res which are self-
ion pertaining to a

receiver models;—

AR!

1941 makes it
the radio industry
tant saving to all

A PERMANENT INSTITUTION

Radio Circuit Manual—1941 is NOT a one-time manual. Next year there will be a Radio Circuit Manual—1942, the following year, 1943, and so on—each Manual better than the last—each Manual better than any other Manual. New methods are worked out for and simplifying the work of the practicing Service Engineer.

Radio Circuit Manual, Inc.
New York, N. Y.

RADIO CIRCUIT MANUAL — 1941

SENTINEL RADIO CORPORATION
MODEL 210B

SPECIMEN PAGE (greatly reduced)

THE ACTUAL PAGE SIZE IS 10 By 12 3/4 Inches

ALIGNMENT PROCEDURE

Be sure to follow procedure carefully and in the order given—otherwise the receiver will be insensitive and the dial scale incorrect. For alignment procedure read subsections from left to right. If more than one adjustment is required check tuning dial adjustment by tuning gang condenser until pointer touch maximum capacity stop (completely to dial calibration). If dial needle does not point exactly to last line mark to correct position. Use an accurately calibrated test oscillator with scope type of output measuring device. Always ground lead of test oscillator attached to chassis.

Set oscillator dial to	Adjust test oscillator frequency to	Use dummy antenna in series with output of test oscillator consisting of	Attach output of test oscillator to	Refer to parts list for location of trimmer condenser
I.F. Any point where no interfering signal is received	455 K. C.	50 MFD. condenser	High side to grid terminal of 1A7G tube DO NOT REMOVE CAP.	Adjust each of the second I. F. transformer trimmers for maximum output 4 the first I. F. transformer for maximum output
1 Exactly 1720 K. C.	Exactly 1730 K. C.	20025 MFD. condenser	Receiver blue antenna lead	Adjust 1730 K. C. oscillator trimmer for maximum output
2 Approx. 1400 K. C.	Exactly 1400 K. C.	20025 MFD. condenser	Receiver blue antenna lead	While rotating gang condenser adjust 1400 K. C. trimmer for maximum output
3 Approx. 800 K. C.	Approx. 800 K. C.	20025 MFD. condenser	Receiver blue antenna lead	While rotating gang condenser adjust 800 K. C. trimmer to maximum output

PARTS LIST

Qty.	Part No.	Description
1	11125	Cable
1	1201	Coil
1	1204	Coil
1	1205	Coil
1	1207	Coil
1	1208	Coil
1	1209	Coil
1	1210	Coil
1	1211	Coil
1	1212	Coil
1	1213	Coil
1	1214	Coil
1	1215	Coil
1	1216	Coil
1	1217	Coil
1	1218	Coil
1	1219	Coil
1	1220	Coil
1	1221	Coil
1	1222	Coil
1	1223	Coil
1	1224	Coil
1	1225	Coil
1	1226	Coil
1	1227	Coil
1	1228	Coil
1	1229	Coil
1	1230	Coil
1	1231	Coil
1	1232	Coil
1	1233	Coil
1	1234	Coil
1	1235	Coil
1	1236	Coil
1	1237	Coil
1	1238	Coil
1	1239	Coil
1	1240	Coil
1	1241	Coil
1	1242	Coil
1	1243	Coil
1	1244	Coil
1	1245	Coil
1	1246	Coil
1	1247	Coil
1	1248	Coil
1	1249	Coil
1	1250	Coil
1	1251	Coil
1	1252	Coil
1	1253	Coil
1	1254	Coil
1	1255	Coil
1	1256	Coil
1	1257	Coil
1	1258	Coil
1	1259	Coil
1	1260	Coil
1	1261	Coil
1	1262	Coil
1	1263	Coil
1	1264	Coil
1	1265	Coil
1	1266	Coil
1	1267	Coil
1	1268	Coil
1	1269	Coil
1	1270	Coil
1	1271	Coil
1	1272	Coil
1	1273	Coil
1	1274	Coil
1	1275	Coil
1	1276	Coil
1	1277	Coil
1	1278	Coil
1	1279	Coil
1	1280	Coil
1	1281	Coil
1	1282	Coil
1	1283	Coil
1	1284	Coil
1	1285	Coil
1	1286	Coil
1	1287	Coil
1	1288	Coil
1	1289	Coil
1	1290	Coil
1	1291	Coil
1	1292	Coil
1	1293	Coil
1	1294	Coil
1	1295	Coil
1	1296	Coil
1	1297	Coil
1	1298	Coil
1	1299	Coil
1	1300	Coil

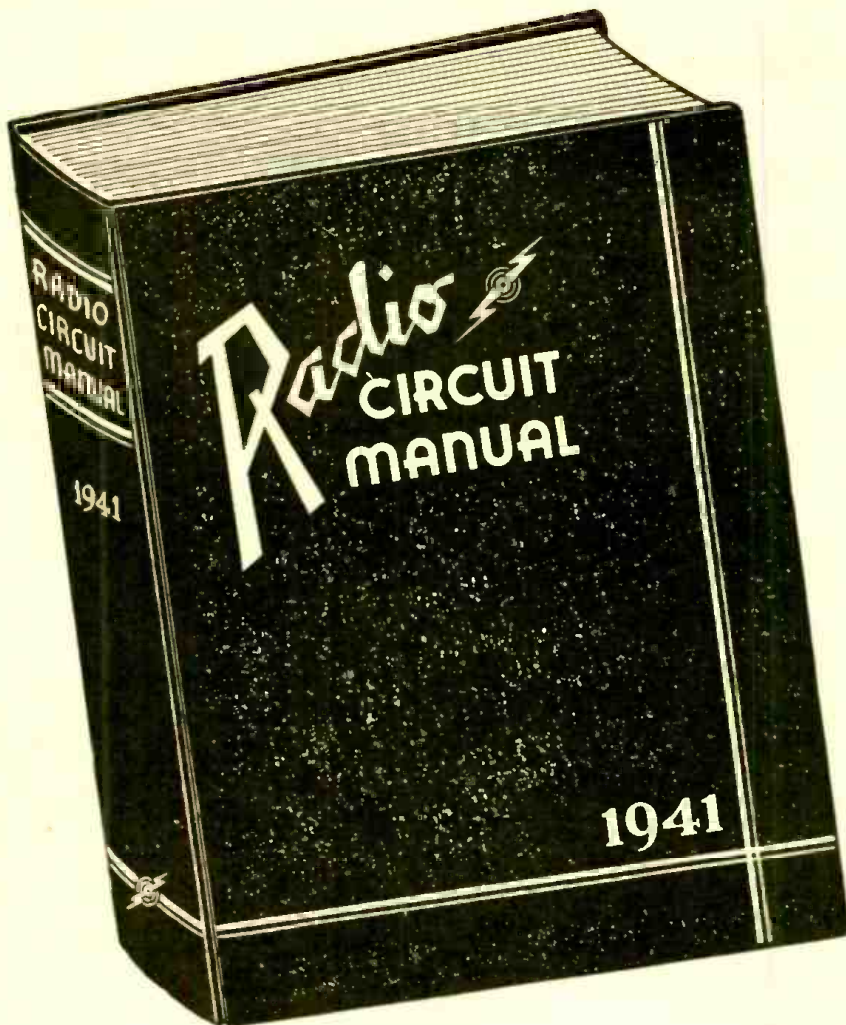

A New RADIO

The Only **EDITED** Manual
Ever Published!

DIRECTORY OF RECEIVERS
MANUFACTURED IN 1940
AND UP TO JUNE, 1941

OUTSTANDING FEATURES

- Contains data on more than 1800 receiver models!—more than any other radio service manual.
- Only 736 pages!—less than half the bulk of any other manual and more than 1/3 lighter.
- All information is **EDITED!**—all non-essential data deleted and the balance checked and correlated with the schematics and sketches.
- 40% larger of all information (A few unaccepted.)
- I.F. peaks on circuits are black boxes—accurate.
- No space was wasted on conditions and explanations, etc. (No space was wasted on conditions and explanations, etc.)

A "CUSTOM-TAILORED" MANUAL FOR SERVICE ENGINEERS

Here, at last, is a Service Manual deliberately **PLANNED** for the Service Engineer. Instead of a mere hodge-podge collection of service data, as manuals have been, this **RADIO CIRCUIT MANUAL** is an orderly compilation of essential service information, carefully edited and uniformly presented for the convenience of the busy Service Engineer. All time-consuming, non-essential information has been weeded out, and the remaining information, vitally important to the servicing of modern radio receivers, has been laid out in a logical, which cuts time from the day's work. Because of this and other features evident upon first observation, it has been possible to list all information on a single page.

In 736 pages this Manual presents essential service data on over 1800 more than any other existing service manual on the market!

ONLY ONE MANUAL PER YEAR

The new technique used in compiling this **RADIO CIRCUIT MANUAL** makes it possible to include in a single book all the new receiver models which can be produced in a single year. This factor alone represents an important advantage for Service Engineers.

ORDER YOUR MANUAL IMMEDIATELY—NOW!

Get your copy directly from us by filling out and mailing the convenient coupon shown at left, or get it directly from your favorite distributor.

736 pages; size 13 $\frac{3}{4}$ x 10 $\frac{3}{4}$ x 2 in. thick; loose leaf, leatheroid-covered stiff binder; net weight 6 $\frac{1}{2}$ lbs.

ONLY
10⁰⁰

This Radio time prop. Circuit Manual and so on the other expediting Ser

RAD CRAFT PUBLICATIONS

25 W. BROADWAY

NEW YORK

RADIO-CRAFT for NOV.-DEC. 1941



← THE OLD TYPE MANUALS—Bulky, heavy, hard to handle, space consuming, less USEFUL data despite greater number of pages.



→ OUR NEW MANUAL—Lighter, compact, easy to handle, takes half as much room on the shelf, more USEFUL information despite fewer number of pages.

MANUALS NOW READY!

RAD CRAFT PUBLICATIONS, INC., 25 West Broadway
New York, N. Y.

Gentlemen: Enclosed find my remittance of \$10.00, for which send me, POSTPAID, my copy of the RADIO CIRCUIT MANUAL—1941.

Name

Address

City State

RC-1041

(Send remittance in form of check or money order; register your letter if you send cash.)

**DISPOSAL SALE
AMPLIFIERS & PARTS**

THIS sale comprises parts used in the construction of Juke-Boxes; made by well known amplifier manufacturers such as: Rauland and Operadio. All equipment is reconditioned and in perfect mechanical and electrical condition.

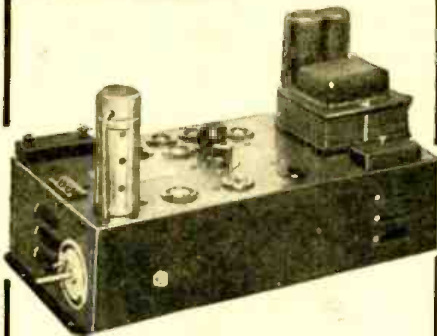

12 WATT PUSH-PULL 2A3 AMPLIFIER
Tube complement 2-2A3, 1-56, 1-57 and 1-5Z3. To be used with one or two 2500 ohm dynamic speakers 16 ohm voice coil. May be changed over to use P.M. speakers. Input for magnetic pickup. Variable tone control. Schematic furnished to change unit over to use crystal pickup, crystal microphone and P.M. speakers.
Shipping Weight 25 lbs. \$7.95

15 WATT PUSH-PULL 6B5 AMPLIFIER
Tube complement 2-6B5, 1-6A6, 1-6A6, 1-76 and 1-5Z3. To be used with one or two 2500 ohm dynamic speakers 16 ohm voice coil. May be changed over to use P.M. speakers. Input for magnetic pickup. Variable tone control. Schematic furnished to change unit over to use crystal pickup, crystal microphone and P.M. speakers.
Shipping Weight 22 lbs. \$8.95

30 WATT PUSH-PULL 6L6 AMPLIFIER
Tube complement 2-6L6, 1-6A6, 1-6C6, 1-5Z3. amplifier as is, has input for magnetic pickup, volume control, variable tone control. Supplies field current to one or two 2500 ohm dynamic speakers, output impedance 2.6, 3.2, 4, 5.3, 8, and 16 ohms. Full 30 watts output. Schematic furnished to change unit over to use crystal pickup and crystal, dynamic or velocity microphone and change over to use P.M. speakers.
Shipping Weight 25 lbs. \$10.95

All Amplifiers Less Tubes & Speakers.



**JENSEN 10 INCH
ELECTRO-DYNAMIC
SPEAKER**

2500 OHM
FIELD
16 OHM
VOICE-COIL

EACH \$2.69

Shipping Weight 7 lbs.

**R.C.A. MAGNETIC
PICK-UP HEAD**

IMPEDANCE 3000 OHMS

Ship. weight 1 lb. EACH **\$1.89**



**NATIONALLY ADVERTISED TUBES
(in sleeves)**

Ship. weight ea. 8 oz. Additional tubes 4 oz. ea.

6L6G	6N7	56
6B5	53	57
2A3	6A6	6C6
		76
		5Z3
Each .49	Each .30	Each .25

ORDERS SHIPPED SAME DAY AS RECEIVED. All goods are sent Express collect if no money for Parcel Post is included in remittance. Customers in Foreign countries are requested to remit in U. S. currency or International Money Orders and include enough money to ship goods prepaid.

**PEERLESS RADIO
AND SOUND CORP.**

25 S. JEFFERSON ST., CHICAGO, ILL.

ly too, that too low a bid has often been misinterpreted by School authorities as an indication of inferior merchandise. The lowly one-dollar flat-rate charge for radio service to the public may entice more business, but in school sound work you are dealing with a group of intellectual individuals, to whom long-lived performance at a slightly higher price spells low-cost operation over a long term period! All of which—summed up—just means that the cheapest price may prove the most costly in the long run.

Getting down to basic instances, let us say that following the school board meeting, the school has decided to receive bids. In a large institution the specifications will be available from the business office in typed or printed form. In the case of a smaller school, the principal may merely tell you the requirements. In either event, they will include the number of classroom speakers, the number for the auditorium, the gymnasium, the athletic field, etc. If possible at all, get these in printed or typed form from the School. It will later eliminate trouble of the sort which starts with "You misunderstood me, I meant this—"

Obtain Blueprints: At this time it is for your own good to secure a set of building blueprints. Should the School have only one set, ask them to have duplicates made. If this meets with a pause and a frown, immediately offer to have it done if they will loan you the original set. And be absolutely positive that the blueprints you receive are complete, up-to-date and show all recent and past building remodeling projects and additions.

With blueprints and specifications in your hands and a thorough mental picture of the individual rooms in your mind, return to your shop and meditate. Don't stop there but live with this job until it's yours to work on. By all means do not put it on the shelf, consoling yourself with the hope of getting at it tomorrow, for tomorrow you will hopelessly repeat to yourself the same promise. Instead, keep at it; the same evening you take it home with you.

This is your opportunity to gain a higher reputation and greatly increase your yearly income by one single job. Get into the feeling of playing a game—a game which you have every right to be engaged in. A contest in which your very technical background has provided you with the necessary confidence with which to succeed. So, in the peace and calm of the evening, spread out blueprints and specifications and plenty of paper and get down to work.

You've been told where the amplifier is to be located. Mark this location on the blueprint with a penciled mark which later can be erased. Do likewise with all classroom and auditorium speakers. A scale of feet will usually be indicated on the blueprint. Use this to your advantage. The first task is measuring speaker wire needed. Suppose the scale indicates the blueprint is drawn 1/4 inch to the foot.

Measuring will be much easier if a piece of cardboard about 12 inches long and one inch wide is divided into quarter inch markings, numbered from one to ten or so. For all practical purposes this provides a ruler for measuring feet on the blueprint and is quicker to read than interpolating from a standard 12 inch ruler. Using the position of the amplifier in the building as a base, measure the distance from the exact location of the speaker in each individual classroom to the amplifier. Remember to follow partitions and bear in mind that, while the shortest distance on the blueprint may appear to be along the walls, the actual wire can often be strung faster and far easier through air ventilator shafts. These, of course, are shown on the blueprint. Something that even the best of electrical contractors neglect to consider occasionally is the ceiling heights. This, obviously, is an oversight; but it can happen to you unless it is guarded against. If the distance between room speaker and amplifier is measured and the ceiling height omitted, the final or total length of wire needed may be in error to a serious degree. After each individual measurement has been placed on paper, all are totaled. To this total add 10% of the length to handle unforeseen, but required wire length. Where a speaker line or lines must be run out-of-doors and undoubtedly underground, this will indicate the use of lead-covered or conduit cable. This must be listed separately, because of the difference in cost.

Submitting Itemized Bids: With the wire computed, it is still necessary to list the total number of speakers, baffles, projectors and trumpets. Mike and amplifier cabinet must also be indicated. This brings up the subject of the itemized bid. Some are decidedly against this form. It must be admitted, however, that an itemized bid submitted to the school authorities carries with it an air of fairness and responsibility. Such procedure then, must, by its nature, promote confidence in your sincerity and honesty. Figure 1 shows a sample quotation. Notice that it is specific as to the amount, model number and description of the proposed apparatus. The total price is indicated in the lower right hand column. After the entire bid has been completed and typed in triplicate, it is good business procedure to accompany it with a short letter to the school. This brief should state the total price of the installation and refer to the enclosed itemized bid. Before going further, let's clarify the reason for a triplicate copy of the bid. The original and one copy are included with your letter. The remaining copy is for your files. When and if the school places its order with you, it merely returns one copy to you while it still retains its original quotation for reference. This is standard procedure with many business firms and prevents much trouble later on since each party is supplied with pertinent records.

The question here arises as to labor costs.

"TYPICAL BID" FIG. 1.

Prepared by Rex Radio & Sound Co., 1423 Laramie, Denver, Colorado
For West Side High School, 1132 Fortney St., Mexico, Colorado; Burnsville, Colorado

1 Model 621A, Farco Twenty-Room Sound System Unit, complete	\$225.00
20 Model 45, Jencor 12 in. Dynamic Speakers with built-in Exciters, @ \$14.00	280.00
20 Model BA, Walnut Finished Wall Baffles, @ \$5.00	100.00
4000 Ft. (40 Rolls, 100 Ft. Each) No. 19 Twisted Pair Telephone Wire, @ \$2.00	80.00
1 Model X7T, Amer. Electro Dynamic Mike with 25 Ft. Cord	32.50
1 Model SD28, Airco Microphone Desk Stand	4.80
Miscellaneous Hardware	3.00
Equipment Price	\$725.30
Labor	125.00
Complete School Sound Installation—TOTAL	\$850.30

own group in the radio industry. More on this subject later.

Personal appearance is very important: It goes without saying that the neatest dressed man creates the most favorable impression.

Reasons for wanting a School Sound System: What are the reasons for wanting a School Sound System? That is the question which any school principal may put to you as you approach him on the subject. True enough he knows he can talk to his students in their respective classrooms. But usually he is in a position to be enlightened beyond that point. Knowing the capabilities of your system places you in a decidedly favorable spot as the salesman. Concrete advantages to the school result from the sales features found in the school sound system.

The principal must know and realize clearly that the more advantages found in his institution of learning, the greater the drawing power from a viewpoint of student enrollment. This is especially true in the case of private schools and colleges. It becomes, then, your problem, to interpret to the principal or School board the enrollment inducement in terms of School advantages. To substantiate your claims, cite the advantages of a competitive school over his own. Tell of their School Sound System and the functions it is now performing to the benefit of a more modern and advanced institution as compared to this one, not yet so equipped. As a review among ourselves, let us see what the modern school sound system can do every day to make any school a better, more interesting house of learning.

Probably best known is its ability to allow the principal to personally deliver important messages to any room or group of rooms without sending some one person on the rounds as a messenger. Together with this may be installed the "Talk-Back" feature which permits the instructor to answer the query of the principal's office immediately and from anywhere in the classroom by merely talking at the loud-speaker.

The sound system permits the entire student body or the civics class alone, without leaving their individual class-rooms, to hear eminent authors, statesmen and dignitaries as they are tuned in on the master built-in radio tuner. Likewise a visiting school authority may speak to all or any one school room from the principal's office without having the students go to the main assembly or lecture hall.

Music classes can be enhanced by tuning in the "Music Appreciation" programs broadcast on the national networks; likewise Radio Homemakers Hours may achieve a similar purpose when they are heard by an attentive "Domestic Science" class.

In some schools the signal for class changes is a record of martial music, the impelling rhythm commanding students to orderly march from room to room. Furthermore the same built-in record player may furnish light, danceable tunes for school hops and noon-hour entertainment.

The old-fashioned, strident fire alarm system is replaced by the tune of a well-known marching composition, heard in every class-room and every nook and cranny of the school.

Using the same sound system, speakers can be placed in the school auditorium, field house, gymnasium or athletic field, thereby serving a dual purpose at only a fraction of the cost of individual sound systems; yet this very feature permits all year round use for such affairs as Commence-

ment exercises, football and basketball games, field meets, etc.

All of the above has been written to help the serviceman-dealer who in his first contact must *sell the idea* of the sound system to the school authorities.

How to Answer Questions: It is quite probable, that, as frequently happens before any actual bids are submitted, a meeting of the school board will be held, with a purpose toward deciding just what is needed, how many rooms are to be sound-equipped; how many speakers will give adequate coverage in the school auditorium, and any number of things which are only questions in the minds of those who are to spend the money. At these meetings, it is very likely that, if you are the accepted community authority on *Sound* installations, you will be called to act as technical adviser. You will be bombarded with questions, simple and complex; the kind that can be answered immediately as well as those which require your careful research. It follows that in a position like this, you can establish yourself as the sound expert of the community. Likewise, you can forevermore ruin your valuable reputation.

In a meeting of this kind, it is best to save your sales talk for the future; you may need it later. The mere fact that you have been called in as an expert proves that some one has confidence in your ability. By being present you have been placed in a position to instill that very same confidence in the other board members. Helpful information in plain understandable English is what they demand. In the ordinary course of affairs you will not be asked actual technical questions. However, it may happen that before the meeting some one party has curiously paged through a mail order catalog and allowed his interest to roam to technical specifications. This is the fellow who invariably will ask, through the smoke of his cigar, "Will we need all the 'db.'s' now or can we add more later on?" With a question like this out of a clear sky, it is difficult to know whether or not the individual is trying to phrase his question in the way he knows best, or does he know what he is talking about? In such a situation it is wise to be the diplomat. The man may be sincere after all; he may want to talk of power and firmly believe he is using the proper phraseology. So to avoid the "acute angle" answer the question something like this: "Yes, if the school installs a powerful enough system to begin with, a number of speakers can be added later without incurring the expense of additional amplifier equipment." Notice that no attempt has been made to define the meaning of "db." The idea is to avoid delving into any out of the ordinary course of the conversation. By all means do not attempt to teach radio theory during the meeting.

Generally it is best to keep yourself in the conversational background. If you are asked a question, answer it clearly, precisely and, I repeat, in plain non-technical English! If you feel a recommendation for the good of the school is appropriate, ask for the floor, state your expert opinion and be seated.

THE BIDDING

While in many smaller communities the sound installation job is merely given to the local serviceman-dealer without the formality of competitive bidding, most school installation jobs are secured by successful bidding. It is comparatively easy to secure the low bid and the resultant contract; it is exceedingly difficult to show a fair net profit on a bid, which, later you find was ten times lower than it needed to be. Past experience has proven, and very conclusive-

Big Profits FROM NEW BUSINESS SELLING GTC PORTA-POWER

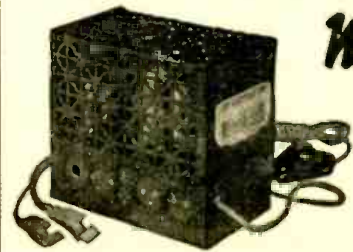

New!

**GTC
MODEL
"C"**

FOR NON-ELECTRIFIED RURAL DISTRICTS

*Operates from 6-Volt
Storage Battery*

Replaces "A" and "B" batteries in 1½ volt portable or farm radios, having 4, 5 or 6 tubes. Supplies 1½ "A" and 90 volts "B." Gives high quality reception at low cost operation.

List price \$13.50—**COSTS YOU \$8.10**

For R. E. A. DISTRICTS use these GTC PORTA-POWER

**MODELS
to Convert Battery
Radios to Power
Line Operation**

MODEL "P" For 6 volt radios "Twin-Powered"

Converts 98% of all 6 volt radios. Vibration disturbance is eliminated. High fidelity performance assured.

List price \$15.00—**COSTS YOU \$9.00**

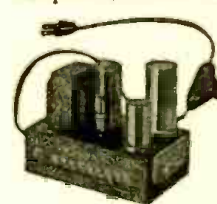

MODEL "L"

For 2 volt radios
Supplies "A" and "B" and "C" power to 4 to 8 tube battery-operated radio sets using 2 volt tubes.

List price \$11.00.
COSTS YOU \$6.60

MODEL "U" For 1½ volt portable or farm radios

Powers any 4 or 5 tube portable or farm radio using 1½ volt tubes. Provides "A" and "B" power. List price \$8.50.

COSTS YOU \$5.10

MODEL "G" For 1½ volt radios of 4, 5, or 6 tubes

For 1½ volt radios of 4, 5, or 6 tubes requiring more power than Model "U" provides. List price \$10.50.

COSTS YOU \$6.30

*Free Literature and Further
Information on Request*

GENERAL TRANSFORMER CORP.
1254 W. VAN BUREN ST. • CHICAGO, ILLINOIS

consideration, as well as the proper plate load.

PHASE INVERTER

Direct coupling between the first audio stage and the phase inverter was made practical by matching the first audio stage plate operating voltage to the voltage proper for the phase inverter tube grid, which is 100 volts. A study of the voltages in Figure 3 reveals that the plate supply volts for the first audio stage is 250 volts. This tube draws 1 mil. (ma.) plate current, causing a 150 volt drop in the combination of R-2 and R-3, developing an operating potential of 100 volts for its plate, and, by virtue of the direct coupling, the same potential for the grid of the phase inverter tube. This voltage automatically biases the 6J5 phase inverter tube to where its plate current is approximately 2 mils. This current causes a voltage drop of 102 volts across R-4 and a similar drop across R-5, leaving 158 volts as measured from plate to cathode of the phase inverter tube. Thus, it can be seen that the 362 volt plate supply for the phase inverter tube is fairly well divided between R-4, R-5 and the phase inverter tube itself. R-2 is the first stage plate resistor and R-3 performs the dual function of filtering and dropping the voltage to the proper level at the point of the direct coupling, i.e., 100 volts.

While there is no gain in this phase inverter, a redeeming feature is the fact that the inverted signals are always 180° out of phase, regardless of frequency, and no unbalanced condition will result from changed tube characteristics due to aging.

The plate voltage supply for the phase inverter tube was selected purposely high

in order to avoid too low a potential on the plate of the first audio stage. As can be observed, the plate voltage of the first audio stage and the cathode voltage of the phase inverter tube are practically the same, with the exception of a few volts of automatic bias that are developed in the phase inverter cathode resistor. This high voltage is taken from the output stage plate supply where 375 volts are available. Additional filtering was required at this point to keep all traces of A.C. out of the phase inverter stage. This is adequately accomplished by choke 1 and the 8 microfarad electrolytic condenser C-2.

Care was exercised in selecting the phase inverter cathode resistor R-4 and the phase inverter plate resistor R-5 to be certain of obtaining as near a match as possible between the two. This was done by measuring the resistance of six 50,000 ohm resistors with a sensitive ohmmeter, and choosing two that were identical in resistance value. Resistors selected at random may vary as much as 20%.

The first audio stage and power transformer and filter section are not on the same chassis shown in the photograph in Figure 1. They are on the tuner chassis which is used with this amplifier for the reception of radio broadcasts. The tuner is not shown. The power supply is conventional, as can be seen in the schematic diagram in Figure 2. The phase inverter, push-pull driver stage and push-pull outlet stage are on the chassis pictured in Figure 1, and are within the dotted line portion of the schematic diagram in Figure 2. Heavy stranded filament wires are used to convey the filament current and voltage to the amplifier. Each filament wire is connected to two pins on the plus to

which they connect, and, correspondingly, two lugs on the plug socket are joined, to avoid the possibility of a voltage drop and consequent heating at this juncture.

Parts List

- RESISTORS**
 One I.R.C. 2500 ohms, ½ watt, R-1;
 Three I.R.C., 50,000 ohms, ½ watt, R-2, R-4, R-5;
 Four I.R.C., 0.1 megohm, ½ watt, R-3, R-11, R-12, R-13;
 Two I.R.C., 0.5 megohm, ½ watt, R-6, R-7;
 One I.R.C., 500 ohms, 1 watt, R-8;
 Two I.R.C., 20,000 ohms, ½ watt, R-9, R-10;
 One I.R.C., 25,000 ohms, 25 watt, wire wound, adjustable, R-14;
 One I.R.C., 200 ohms, 10 watt, wire wound, adjustable, R-15.
- CONDENSERS**
 One Aerovox type 2GL Hi-Farad dry electrolytic, 8-8 mf., 450 WV DC., C-1, C-2;
 Two Cornell-Dubilier type DT-6S1, paper, .01 mf., 600 V., C-3, C-4;
 Two Cornell-Dubilier type DT-6P1, paper, .1 mf., 600 V., C-5, C-6;
 One Aerovox type 284, paper, 1 mf., 200 V., C-7;
 One RCA type 5212, dry electrolytic, 18 mf., 450 WV DC., C-8;
 Two RCA type 2467, wet electrolytic, 30 mf., 450 WV DC., C-9, C-10;
 One Aerovox type PR50, dry electrolytic, 50 mf., 50 WV DC., C-11;
 One Aerovox 684, paper, .02 mf., 600 V., C-12;
- TUBES**
 Four RCA type 6J5;
 Two RCA type 6L6G;
 One RCA type 5T4.
- MISCELLANEOUS**
 One Thordarson Choke type T-37C36, Choke 1;
 One Thordarson Choke type T-67C49, Choke 2;
 One Thordarson Tru-Fidelity Transformer, push-pull input, type T-2A42, T-1;
 One Thordarson Tru-Fidelity Transformer, push-pull output, type T-3S21, T-2;
 One Thordarson Power Transformer, type T-13R16, 200 ma. at 400-6400 V.; 4 A. at 5 V.; 5.14 A. at 6.3 V.; T-3;
 One I.R.C. 2 megohm potentiometer, vol. control;
 One I.R.C. 0.15 megohm poten., tone control.

Wiring diagram of the High-Quality Amplifier.

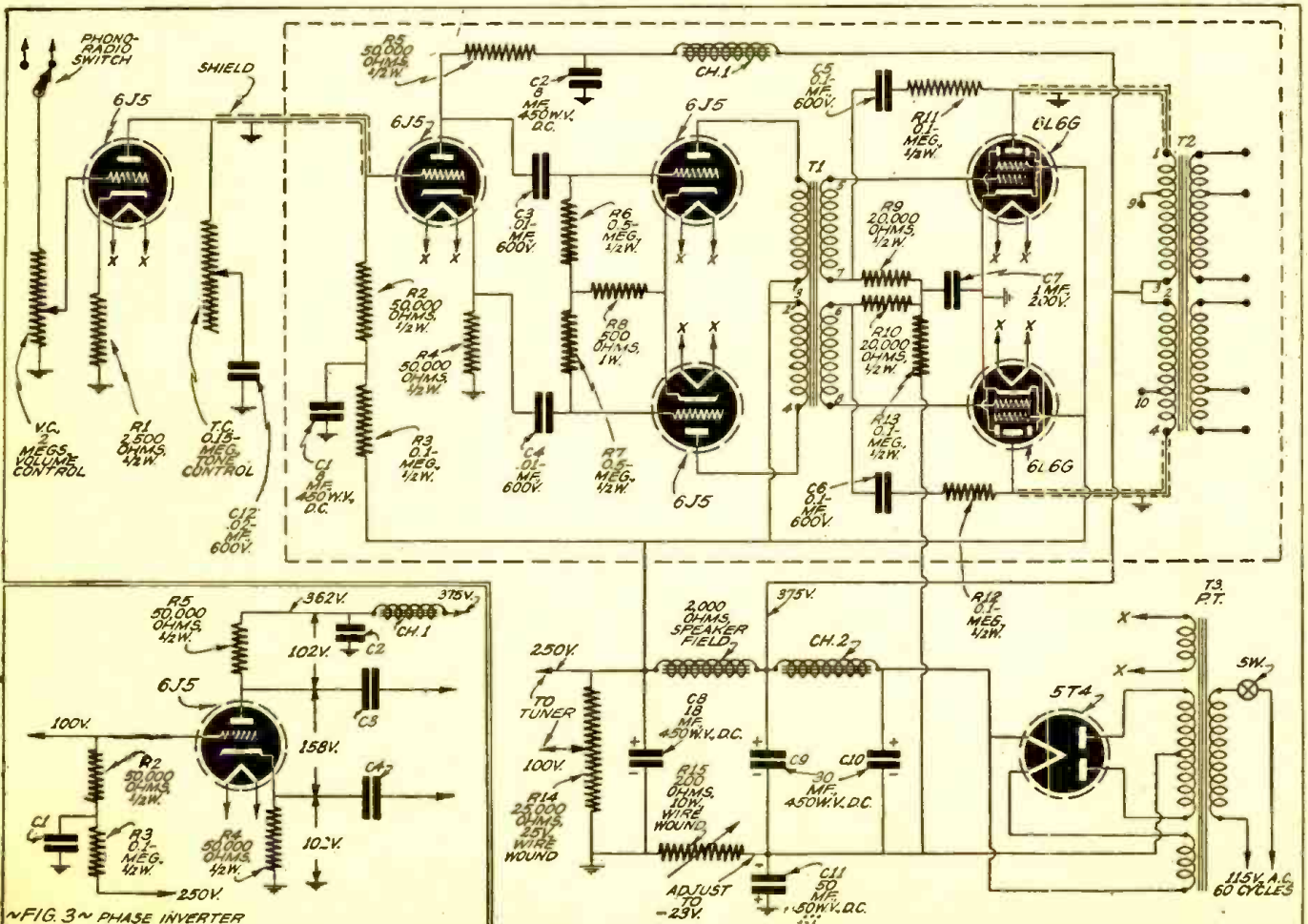

COIL COUPLING PROBLEMS

L. V. SORENSEN

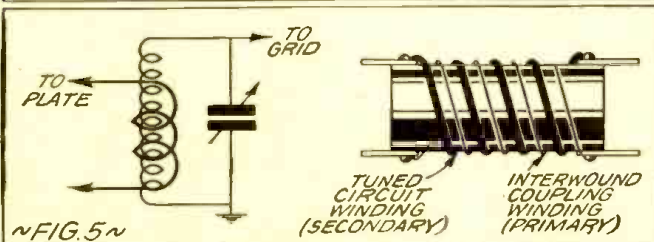
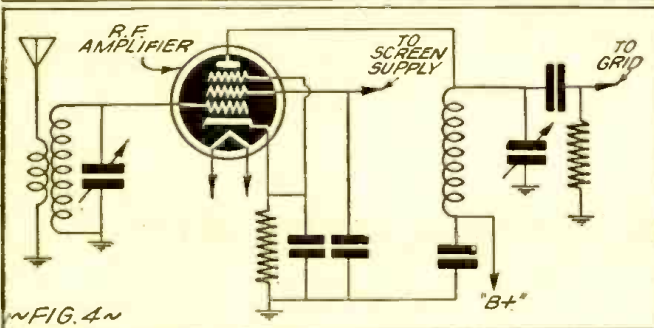
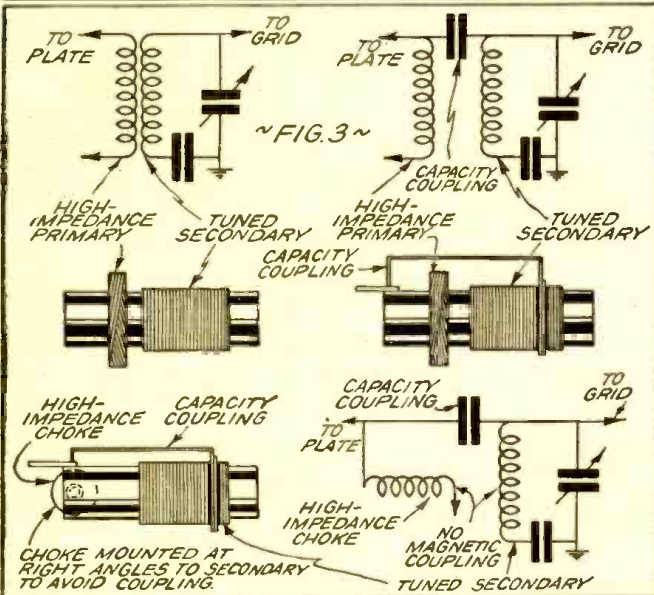
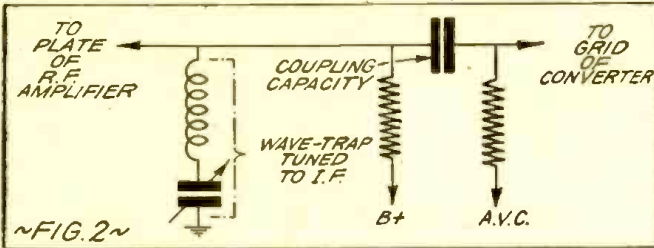
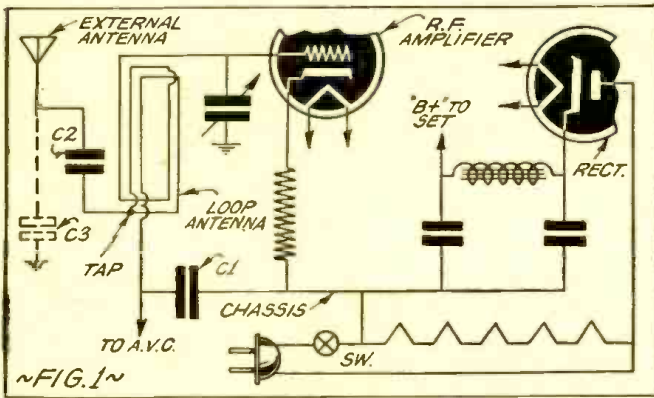

The circuit diagrams given above are explained in the text and the important role played by the coupling coil in radio receiving circuits especially, are discussed at length by the author. The loop antennas used so widely on portable sets has required some fine engineering, to properly solve the problem of the best type of coil for the purpose.

The author explains in an easily understood manner, some of the problems met with in radio design, so far as the coils and coupling methods are concerned. Every student of radio technique will find many valuable pointers in this article. Some of the topics are—Loop Antennas, Reducing Hum Modulation, Effect of High Impedance Primaries, Short-Wave Coils and R.F. Amplifiers.

PART I

EVERY radio set employs resonant circuits to select the desired signals and to discriminate against the undesired signals, but the methods by which these resonant circuits are coupled into the preceding and following tubes or circuits vary widely as conditions dictate. It is the purpose of this article to discuss the general methods used to couple tuned circuits into radio receivers, outline the general characteristics of each method, and to point out the limitations that influence the type and amount of coupling.

LOOP ANTENNAS

A loop antenna is the outstanding example of a simple method of coupling a resonant circuit to a tube. The entire tuned circuit is directly connected between the grid and the cathode return of the first tube. Signal voltage is introduced into the loop by direct induction from the signal field existing in space.

When the signal from the desired station is too weak for satisfactory reception on a loop, it is necessary to couple an outside antenna to the receiver. The most common method of coupling is to connect the antenna to a few turns of wire wound around the loop. When the loop is of relatively large diameter the coupling winding is frequently only a single turn. When the loop is small in diameter, and consequently requires many turns of wire to make up the required inductance, the coupling winding frequently has several turns in place of the single turn used on the larger diameter loops. This type of coupling is known as "low-impedance" coupling. Its characteristics are: low gain at the low-frequency end of the tuning range, very much higher gain (often 5 to 8 times) at the high-frequency end of the tuning range, poor image-ratio, and considerable sensitivity (at the high-frequency end of the tuning range) to variations in antenna capacity.

The principal limitation in the amount of this type of coupling that can be employed is the amount of capacity "reflected" from the antenna across the tuned circuit. When this "reflected" capacity becomes large enough to throw the circuit badly out of alignment with the other circuits in the receiver, a net loss in sensitivity is caused by further increases in coupling. Under such a condition of misalignment the image-ratio suffers very badly. In some sets an isolating condenser of limited capacity, say 50- to 100-mmf., may be connected in series with the coupling winding to limit the maximum capacity that may be reflected across the tuned circuit by antennas of unusually high capacity.

A fairly common variation of the coupling winding just described is to make the coupling *conductive* rather than *inductive*. In other words, instead of using a separate winding for the antenna coupling, a part of the secondary is used for the dual function of coupling winding and for part of the tuned circuit. In construction, this is accomplished by putting a tap on the loop winding one or more turns from the low-potential end of the coil, and connecting this tap to the antenna, either directly or through an isolating condenser. The tapped loop may present some manufacturing advantages over the separate coupling winding, but it has the distinct performance disadvantage of some-

times introducing "hum-modulation" into the received signal. Following the circuit in Figure 1, it can easily be seen how this method of coupling the antenna to the loop introduces hum modulation in AC-DC sets.

Reducing "Hum" Modulation: When the line plug is so connected that side "A" is connected to the "ungrounded" side of the power line, the A.C. line voltage is divided across C1, C2, and C3 in series. Since only C1 has both terminals in the grid circuit this is the only condenser across which an A.C. voltage of power-line frequency can introduce hum into the grid circuit. A moment's consideration of these three condensers in series will show that increasing the value of C1, decreasing the value of C2 or reducing the capacity of C3 (the capacity of antenna to ground) will reduce hum-modulation. Of course, the quickest and easiest method of reducing hum-modulation in the above case would be to *reverse* the line plug. Reversing the line plug, however, will have little effect on hum voltages that the antenna may pick up from high-voltage power lines that may be in the neighborhood of the antenna. A.C. sets with the same type of coupling from antenna to loop may experience similar trouble but probably to a lesser degree, because the power line is not connected to the chassis, but is merely bypassed to it with a relatively small condenser.

If hum-modulation only when the antenna is connected is a complaint on any receiver using the type of antenna coupling shown in Figure 1, it is suggested that the antenna connection be removed from the tap on the loop and that a completely separate coupling winding be wound on the loop, right over the turns formerly included in the antenna circuit.

This new winding should have the same number of turns as there were between the tap and the AVC end of the loop. The AVC end of the new coupling winding should be connected to chassis on an A.C. set, and to "B" minus on an A.C.-D.C. set. In the latter case, an isolating condenser should be connected between the antenna and the high-potential end of the coupling coil while in the former case no isolating condenser is necessary. It is very important that the coupling winding be located at the AVC end of the loop, where the capacity between the coupling winding and the loop adds virtually nothing to the circuit capacity on the loop. If the *coupling winding* is located at the grid end of the loop, the winding will add so much fixed capacity to the grid circuit, that it may be impossible to "trim" the loop to resonance with the oscillator at the proper dial setting.

Capacity-Coupled Antenna: Another scheme for coupling an antenna to a loop is to connect the antenna directly to the grid through a very small capacity—something around 2 mmf. Such a scheme is extremely simple but results in a poor image ratio. To prevent serious mistracking at the *high-frequency* end of the band, it is essential that the wiring from the low-capacity coupling condenser to the antenna terminal or lead of the set have a relatively high capacity to chassis, say 10 to 20 mmf. With such a capacity coupling from the low-capacity condenser to ground or chassis, little change is made in the effective grid-circuit capacity when the antenna is connected to the antenna post, but if the low-capacity coupling condenser is so placed that its lead to the antenna terminal has negligible capacity to ground, the maximum mistracking will result when an antenna is connected.

QUALITY PAYS . . . OR WHY MR. VAN DROOL DROPPED HIS SPOON IN THE SOUP

IT happened during the dinner hour at the Van Drool mansion.

Rich Mr. Van Drool was sipping soup in perfect rhythm to the music of his super de luxe radio console. Suddenly came a noise like a firecracker as a midget condenser—which serviceman Wilbert Fixit had installed just the day before—exploded. Mr. Van Drool jumped, dropped his spoon and swore. What made him so mad, he said afterwards, was not that he dropped his spoon in the soup, but that he burned his fingers getting it out.

That experience taught Serviceman Fixit a lesson. No more midget dry electrolytics for him. He'd use big, full-sized replacements and play safe. One day, however, his jobber gave Wilbert a sample Sprague Atom and some literature about it.

"Guaranteed not to explode!" snorted Wilbert as he read the literature. "Phooey!"

But Wilbert was a methodical man. He put the Atom under test. No matter what he did, it wouldn't explode. Although the condenser was only rated at 450 volts, he had to smack it with over 750 volts before it even broke down. Then Wilbert bought a dozen more Sprague Atoms and found they tested equally good.

While he was testing them, Mr. Van Drool's chauffeur dragged one of the

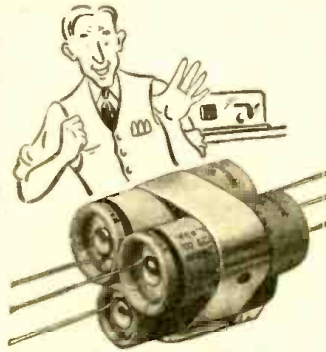

upstairs radios into the shop.

"The boss wants this fixed in an hour," he explained. "And no foolin'. He says it's your last chance."

"Lordy," groaned Wilbert, after examining the set. "A three-section condenser gone bad. It'll take a week to get one from the factory."

Then he thought of his Sprague Atoms and the ST mounting strap the jobber had supplied with them. He

could take two 8 mfd. 350 V. Atoms and a 25 mfd. 25 V. Atom, strap 'em together—and the job would be done. It was the only thing Wilbert could do, so Wilbert did it.

To his surprise the three Atoms when strapped together were actually smaller than the original three-section condenser. Also, his total net cost on the Atoms was only 96c. A duplicate unit would cost \$1.20.

What's more, the Atoms stayed put.

Mr. Van Drool was more than pleased—and that meant Wilbert was pleased, too. Today he uses Atoms for practically all of his replacements, big or little.

"I save 'steen days by using Atoms," is the way he puts it. "I save money, I save shoe leather, I save time, I save my good disposition—and I save customers. Best of all, Mr. Van Drool will never drop his spoon in the soup again."

Drooly yours,

SPRAGUE PRODUCTS CO.,
North Adams, Mass.



No. C-1743 Streamline Cabinet Rack. These cabinets are made in five sizes varying in panel space from 8 3/4" to 35". Standard 19" panel width.

BUD PRODUCTS

for dependable performance

BUD Products are carefully designed and accurately built to precision standards. Only the finest materials are used in their manufacture. That's why they are foremost in trouble-free, dependable performance.

BUD Panels, Chassis and Cabinets are made in a large variety of sizes to fit all amateur and experimental applications. Your jobber will gladly assist you in making proper selection to fit your requirements.

BUD COILS & CONDENSERS

... an efficient combination

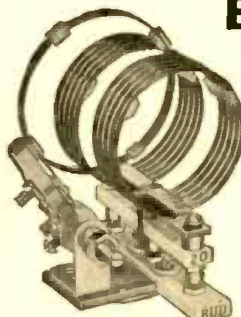

For tank-circuit teamwork—use BUD Coils and Condensers. Both are made in many sizes for application in low, medium, and high-power transmitters. BUD quality construction throughout is your guarantee of efficient performance.

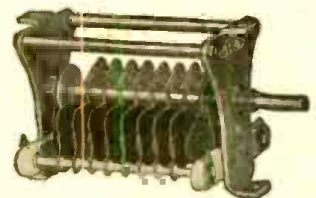

Write for your copy of the No. 241 BUD Catalog.



BUD RADIO, INC.

CLEVELAND, OHIO

Sylvania

SECTIONAL "STOCK BOY" CABINETS HELP YOU SELL

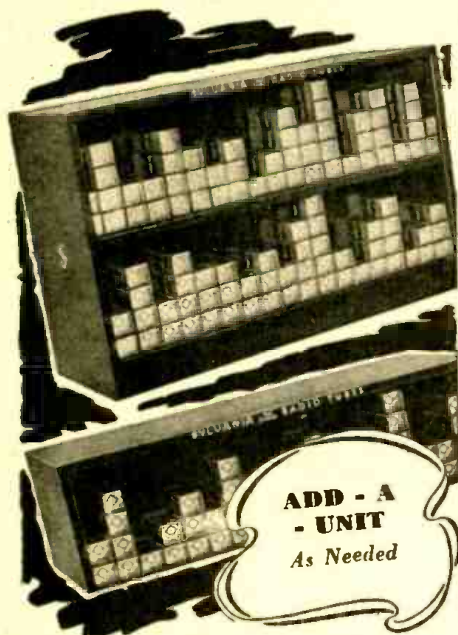

Introducing the new Sylvania Add-a-Unit "Stock Boy"—custom built for radiotube merchandising. You can—

Add shelf sections as needed.
Dress up your store.

Stock tubes for easy accessibility. Eliminate expensive store layout changes incurred by built-in shelves.

Heavy gauge steel . . coated with rich olive enamel . . surface will not crack, peel or chip . . all joints welded . . light weight.

Each shelf holds from 70 to 140 (one row deep) tubes, or as many as 420 tubes by using the full capacity of the shelf.

Ask your jobber how you can get them.

Sylvania Set-Tested Radio Tubes

**HYGRADE SYLVANIA
CORPORATION**
EMPORIUM, PA.

In broadcast radio sets employing conventional antenna coils, the low-impedance primary was abandoned years ago in favor of *high-impedance* coupling to provide better image ratio, flatter gain characteristics from one end of the band to the other, and greater freedom from the *de-tuning* effects of antennas of different capacities. The same idea holds true in the better grades of sets employing loop antennas. These sets are employing high-impedance coupling in either of two forms: (1) a high-impedance primary of large diameter (perhaps 4 to 6 inches) coupled directly to the loop, or (2) a conventional high-impedance primary of the usual diameter coupled rather tightly to a small coil that is connected in series with the loop.

In either case the net result is the same as a conventional high-impedance antenna coil having the same inductances, Q's and coupling capacities. There is no question but what such a method of coupling an antenna to a loop gives better performance than the low-impedance couplings previously described, but many designers have used the poorer coupling circuit because of its economy, and because of the fact that relatively few loop sets ever have an external antenna connected to them.

Large-Loop Capacity Problem: In some sets that cover a rather large tuning range on each band, the distributed capacity of a large-diameter loop, comprising the entire inductance of the tuned circuit, is so high that the tuning range is seriously restricted. In such cases, an effective reduction in distributed capacity can be obtained by separating the inductance of the resonant circuit into two parts, putting approximately half of the required inductance in the loop and the remainder in a small coil of low distributed capacity connected in series with the *high* side of the loop. If this inductance is mistakenly connected in the *low* side of the loop, virtually no advantage has been gained because the capacity of the loop to ground is still connected to the grid. When this capacity is connected to ground, however, with the small coil connected to the grid, the effective circuit capacity is much lower and consequently the tuning ratio is greater.

Sets of the better grade employing the above method of stretching the tuning ratio of the loop circuit, almost always have a high-impedance primary coupled loosely to the above mentioned small coil. Thus, when an outside antenna is connected to the receiver the loop circuit partakes of the desirable characteristics of an antenna coil with high-impedance primary, rather than the less desirable characteristics of the low-impedance coupling scheme that employs one or more coupling turns wound around the loop.

ANTENNA COILS

In general, all *broadcast-band* antenna coils of modern receivers employ high-impedance coupling for the same reasons as given in favor of such coupling in the better grade loop sets. The limiting factor in the amount of coupling that can be used is the amount of mistracking caused at the low-frequency end of the tuning range when antennas of different capacities are used, and by the amount of change in the apparent inductance of the tuned secondary as the low-frequency end of the tuning range is approached. This directly affects the tracking of an antenna coil with an R.F. or oscillator coil.

Effect of High Impedance Primary: Mathematically, it can be shown that actually a high-impedance primary (with an-

tenna connected) reflects a large capacity *in series* with the tuned secondary, giving much the same effect as a padding condenser in that circuit, and that the value of that condenser becomes more disturbing to the normal tuning curve of the circuit as the resonant frequency of the primary circuit (primary inductance with antenna capacity) approaches nearer to the low-frequency end of the tuning range, and as the degree of coupling between the circuits becomes greater. A reasonably good general design specification for coupling in a high-impedance circuit is 15% magnetic coupling and a primary resonant frequency of about two-thirds of the lowest frequency to which the secondary will tune.

In some instances, a little capacity coupling is added to the high-impedance magnetic coupling for the purpose of changing the gain characteristics of the coil. Since the polarity of the *magnetic coupling* between two coils can be reversed by reversing either winding, there are two possible polarities of connections.

With one of these polarities, the magnetic coupling reinforces or aids the coupling provided by the coupling capacity while, with the other polarity, the magnetic coupling counteracts or opposes the coupling produced by the coupling condenser.

When the magnetic coupling *aids* the capacity coupling, the general effect is to raise the gain all over the band, but most effectively at the *high-frequency end*. When the magnetic coupling *opposes* the capacity coupling there is a reduction of gain over the entire band but most effectively at some one point, which may accidentally be in the band in a poorly designed set (or one in which the coil has been accidentally hooked up incorrectly).

This point of minimum response may be made to fall outside of the band at the "image" of some important frequency in the band. When the latter is done the image ratio is improved most at the one point where cancellation of coupling is greatest but the beneficial effects of this opposition of couplings extend for a considerable range on either side of the cancellation frequency. This opposed coupling is most likely to be found in two-gang super-heterodynes where image ratio is seldom as good as may be desired.

Short wave coils almost universally employ low-impedance coupling for several good reasons: (1) A high-impedance winding for the range just higher than the broadcast band resonates in the broadcast band. If this resonance should accidentally fall at the frequency of a local station, the station, in all probability, would cause "cross-talk" on any station tuned in on the *short wave* band in question. (2) Low-impedance coupling makes a much better impedance match between a doublet antenna and the first tuned circuit.

The limiting factor in the amount of low-impedance coupling that can be used on an antenna coil is the amount of mistracking caused by different antennas at the high-frequency end of the tuning range, and by the broadness of resonance of the antenna circuit when aligning with the standard 400-ohm dummy antenna. This is especially important in sets having only a two-gang condenser. If too many primary turns are used, the resistance of the dummy antenna is reflected into the tuned circuit in such an amount that the circuit becomes so broad that it is difficult to distinguish between the desired signal and the image, when the set is working on frequencies such as 16 to 18 mc. with a 456-kc. intermediate frequency and virtually impossible to pad at the low-frequency end.

R.F. AMPLIFIERS

The types of coupling employed in R.F. amplifier stages probably vary more than the coupling in any other kind of a radio-frequency circuit. First, the two general classes of R.F. amplifiers, tuned and untuned, determine whether coils and coil couplings will be employed or not.

The simplest coupling is resistance coupling, in much the same manner as a resistance-coupled audio amplifier with the exception that the values of the coupling resistances and condenser are usually considerably smaller than in audio circuits, and that a trap circuit (tuned to the intermediate frequency) is usually employed to keep out of the converter tube the noises arising in the R.F. tube at the intermediate frequency. If these noises are not suppressed by means of a wave-trap, the "signal-to-noise" ratio suffers. Such a circuit is shown in Figure 2.

Untuned R.F. amplifiers of more complicated design may be used to cover a greater band of frequencies, as in some All-Wave receivers.

The most commonly used tuned R.F. coupling circuits are high-impedance coupling on the broadcast or long-wave bands and low-impedance coupling on the short-wave bands.

The high-impedance circuit for R.F. coupling has several versions: straight magnetic coupling, magnetic plus capacity coupling, and capacity coupling (more familiarly known as choke coupling). These coupling circuits are shown respectively in Figure 3, together with representative examples of coils employing the coupling methods illustrated.

The characteristic of the above type of coupling is a fairly flat curve of gain vs. frequency, especially in the circuit employing combined magnetic and capacity coupling. All of these circuits yield better image ratios than low-impedance coupling, but of these three the circuit employing only magnetic coupling yields better image ratios than either the combined magnetic and capacitive coupling or the straight capacitive coupling (except in the case where the magnetic coupling opposes the capacitive coupling for the specific purpose of improving the image ratio).

In the design of such circuits, particular care should be exercised to see that the primary resonant frequency does not coincide with the intermediate frequency of the receiver, because poor I.F. rejection results when this occurs. If the intermediate frequency is 456 kc. the primary resonance may be between the intermediate frequency and the low-frequency end of the broadcast band, but such a primary resonant frequency requires very close control of coil constants and wiring capacities to keep the resonance at the desired frequency. More uniform and more comfortable production will be experienced if the primary resonance is placed well below the intermediate frequency, where a reasonable variation of resonant frequency will have virtually no effect on the uniformity of the finished sets.

The coupling employed in a few broadcast R.F. circuits of low gain is of the low-impedance type, for reasons of economy and convenience. It is true that the image ratio obtained is not as good as that obtained from a high-impedance circuit, but the image ratio of a complete set employing a stage of such low-impedance amplification is so much better than that of a set without a tuned R.F. stage that some designers use such low-impedance coupling for the economy that results. If they use high-impedance coupling they would unques-

tionably obtain a still better image ratio, but at the price of a primary of many turns of fine wire, and perhaps a mica bypass condenser from the plate of the R.F. tube to plus "B" to cut the gain of the stage, instead of a low-impedance primary of a relatively few turns (10 to 20) of fairly heavy wire.

The coupling employed on short-wave R.F. coils is almost universally of the low-impedance type, in many cases with the primary turns wound between the secondary turns, in an effort to obtain maximum coupling and maximum gain.

The characteristics of this type of coupling on short-wave R.F. coils are: maximum gain at all frequencies, greatest gain at the high-frequency end of the tuning range, and image ratio inferior to high-impedance coupling. This type of coupling is used, however, in spite of this limitation, in order to achieve high gain.

The limiting factor in the amount of coupling so employed is single-stage oscillation in the R.F. tube and/or the amount of capacity reflected from the R.F. plate circuit across the following grid circuit. In order to see how single-stage oscillation is the limiting factor and how to adjust coupling to avoid this difficulty, first consider the circuit in Figure 4.

Inspection of this circuit shows it to have a tuned circuit directly in its grid and plate circuits. If the frequency is anywhere in the range from 2 to 18 mc. the gang condenser is of normal size (365 to 410 mmf.), the coils are of normal "Q" design, and an A.C. tube operating at normal voltages is employed, this stage will oscillate as a tuned-grid-tuned-plate oscillator in exactly the same manner as the old tuned-grid-tuned-plate transmitters operated.

Even with coupling between grid and plate circuit wiring reduced to zero by careful placement of parts, the capacity inside of the tube is enough to cause oscillation when the circuits are properly tracked. It is necessary to reduce the effective impedance in either the grid or the plate circuit of the R.F. tube to stop oscillation. This could be readily done by connecting the plate to some point part way down on the tuned circuit and, as a matter of fact, such an arrangement is sometimes used. The far more common method, however, is to keep the tuned circuit out of the high-voltage D.C. circuit, and merely to couple the plate to this tuned circuit by a separate winding, such as shown in Figure 5.

Since the impedance of any tuned circuit is maximum for the highest inductance, it is obvious that the highest stage gain results on the lowest-frequency band of a multiband short-wave receiver, unless steps are taken to prevent this inequality. The steps usually taken are to use a lower percentage of coupling on the lower-frequency coil. For example, in a certain set the 5.5- to 18-mc. R.F. coil had three-fourths as many turns on the primary as on the secondary, while on the 1.7- to 5.6-mc. band the R.F. primary had only one-third as many turns as the secondary.

This article prepared from data supplied by Meissner Mfg. Co.

(To be concluded)

WASHBURNE NOW SALES ENGINEER

R. D. Washburne, until last month Managing Editor of RADIO-CRAFT, is now connected with an Eastern radio manufacturing and engineering firm as sales engineer.

Mr. Washburne was RADIO-CRAFT'S first managing editor. He was continuously with the magazine since its inception in 1929.



Reach for a DANDEE!

- If ever there was a condenser that could qualify as a so-called universal or general-utility electrolytic, it's the new PRS 450-8 Aerovox Dandee. Why? Because it's the most compact midget metal-can dry electrolytic on the market—a genuine hermetically-sealed job—full-rated capacity and voltage—colored polarity-indicating ends—spun-over jacket preventing shorts and grounds: in a word, a real good electrolytic to fit in tight places.

And for your utmost convenience, these PRS 450-8 Dandees come packed in individual cartons and also in the five-to-the-box or ten-to-the-box cartons. Be sure to have a supply of these handy "universals" always on hand.



Ask for Copy . . .

Our latest catalog is yours for the asking. Ask your jobber—or write us direct. Also ask about a free subscription to the monthly Research Worker.

AERVOX CORPORATION
 NEW BEDFORD, MASS., U. S. A.
 In Canada: AERVOX CANADA LTD., Hamilton, Ont.
 EXPORT: 100 Varick St., N. Y., Cable 'ARLAB'

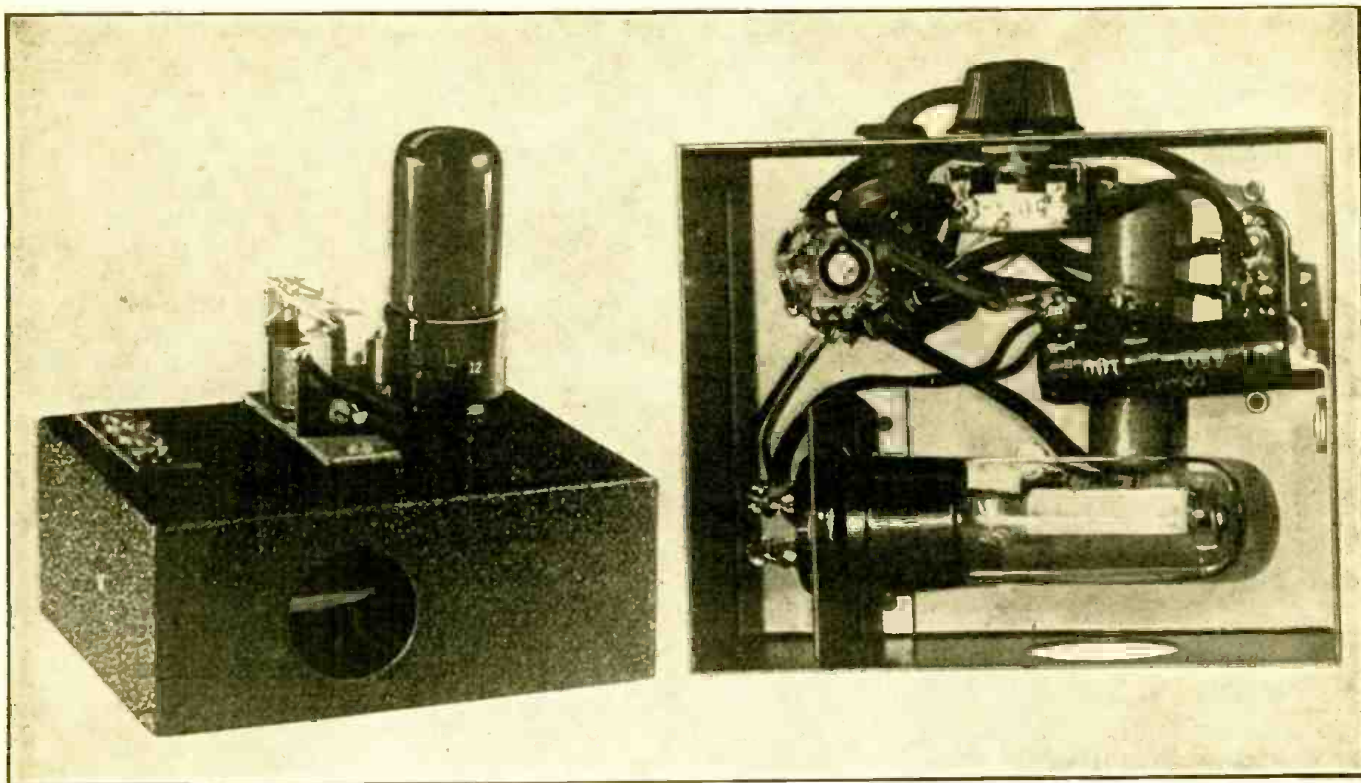

Experimental

PHOTO-CELL RELAY

L. M. DEZETTEL*

The Service Man is frequently called upon to install photocells and relays for performing a number of industrial duties, such as counting the number of objects passing along a conveyor belt, smoke control, lighting control, burglar alarms, etc. This article tells how to do it.

FOLLOWING the article on photo-cell operated burglar alarm systems which appeared in the February, 1941, issue of *Radio-Craft*, many requests were received for the actual construction information on a photo-cell operated unit and details of its use.

We present here a little unit that can be built easily and that will work efficiently. It can be used for almost any number of applications such as counting, announcing, grading, safety control, smoke control, lighting control and as a burglar alarm.

As shown in photo A, the unit is built into a small metal box measuring only 5"x4"x2". The box need not necessarily be made of metal or built that small. The photo-cell is mounted under the chassis in a position so that light reaches it through the 1/4" round hole in the front apron. This is a simple way of keeping extension light from falling on the photo-cell.

The parts are mounted according to wiring convenience and your choice as to location of terminal connections. In this model, the sensitivity control was located on the rear apron of the chassis. It need not be in a convenient location, as it is adjusted only once. The parts are available at radio mail order companies and are inexpensive.

Notice the simplicity of the circuit diagram (Fig.1). Anyone who can wire a simple one tube receiver, can wire this unit. The usual precautions, such as careful sol-

dering, short connections, etc., apply. Be sure to observe the proper polarity of the electrolytic condenser. Connect minus to the plate (No. 3 contact) and plus to the screen (No. 4 contact) of the 50L6GT tube socket. The filament voltages dropping resistor should not be mounted too close to the electrolytic condenser or it may melt the wax out of the condenser.

HOW TO ADJUST UNIT

Adjustment of the completed unit is simple. Plug it into any 110-120 volt A.C. or D.C. supply. Allow a minute for the tube to warm up. Adjust the sensitivity control so that the relay armature just opens. This is a condition of near zero bias on the tube and consequently very little plate current—not quite enough to close the relay. When light falls on the photo-cell, D.C. current gets through the cell and a D.C. voltage appears at the grid, causing the tube plate current to increase, closing the relay.

Using a single-pole, double-throw relay such as we do, there is a wide choice of operations to choose from. The relay contacts may be connected to close a circuit or open a circuit when light falls on the photo-cell. Also, a beam can be permanently fixed to fall on the photo-cell and the contacts hooked up to either open or close a circuit when the beam is interrupted.

The light source should be of a concentrated type. The bulb should have a small filament. A 32 candlepower headlight is a

good source. There are several 110 v. bulbs on the market that are made for projection machines that will do nicely. A lens is used in front of the bulb to concentrate the light into a beam.

Now that we have a photo-cell operated relay going, let's see what we can do with it.

COUNTING

This unit may be used to count packages on a factory belt, people entering a doorway, etc. The beam of light is set up with the photo-cell unit opposite it so that package interrupts the beam as it passes down the line. The relay contacts are hooked up as in Fig. 2. Each time the beam is interrupted, the counter is actuated.

ANNOUNCING

The unit is especially useful for announcing the entrance of a customer in a store. It is installed so that the beam of light crosses the doorway. The circuit is the same as for the counter except that a chime or bell is used in place of the counter and the voltage supply is 6 or 8 volts, A.C.

GRADING

For grading the color of paper, cloth, paint, etc., the unit is set up as in Fig. 3. The beam is thrown down at the material and the relay unit set to receive some of the reflected light. The relay is replaced by a 0-10 ma. meter and the sensitivity control set for a reading of 5 ma. with everything

*Engineer Allied Radio Corporation, Chicago, Illinois

operating. If the material passing under the beam of light is all of the same color, the meter will remain at the 5 ma. reading. If the color becomes lighter, the meter will read higher; if darker, meter reads lower.

SAFETY CONTROL

Here is an important application, yet it is simple to accomplish. The unit is used on power stamping machines to prevent the application of power if the hand is in the press. Install the light horizontally just in front of the point of entrance of the metal being fed the machine. Use circuit Fig. 4. It involves the use of a second relay, having contact points capable of carrying the current required to operate the machine.

SMOKE CONTROL

The photo-cell, installed as in Fig. 5 and using the meter as for grading will register the relative density of the smoke passing through the chimney breach.

LIGHTING CONTROL

The unit may be made to turn on lights in stores and factories or on outdoor signs as evening approaches. The relay unit is installed outdoors, but in glass so that it is weatherproof. It is positioned so that light from the sky reaches the photo-cell. It can be adjusted so that if the sky light drops

below a certain minimum, the relay will be actuated. It, in turn operates a power relay which turns on the lights.

BURGLAR ALARM

First we need an invisible light beam. The source is the same as mentioned, but it must be built into a light-tight box. An infra-red filter is fastened over the light exit. The human eye is not sensitive to infra-red light but a photo-cell is. The beam of light is installed to protect doorways, windows, etc., and a bell connected to the relay contacts as described for announcing.

PARTS LIST

CONDENSERS

1—8 mf. 250 volt electrolytic

RESISTORS

1—50,000 ohm potentiometer
1—20 megohm 1/4 watt carbon
1—400 ohm 10 watt adjustable (adjust to 380 ohms)
1—100 ohm 5 watt

MISCELLANEOUS

1—Amphenol octal socket
1—Amphenol 4 prong
1—3 screw terminal strip
1—Line cord and plug
1—Potter-Brunfield 2500 ohm relay (type MRS-291)

TUBES

1—Cetron CE-T gas-filled, caesium photo-cell
1—Knight 50L6GT

The drawing herewith shows several applications of the Photo-Cell Relay.

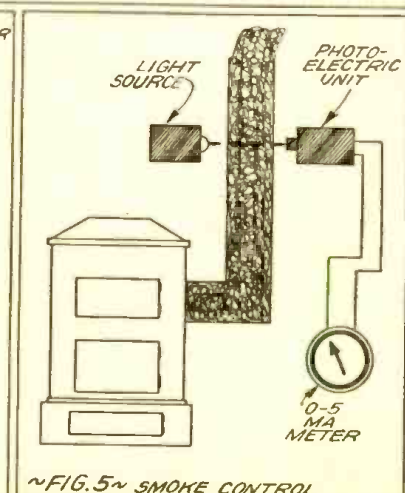
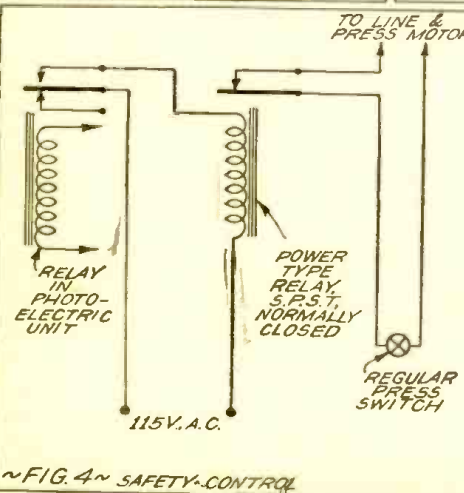
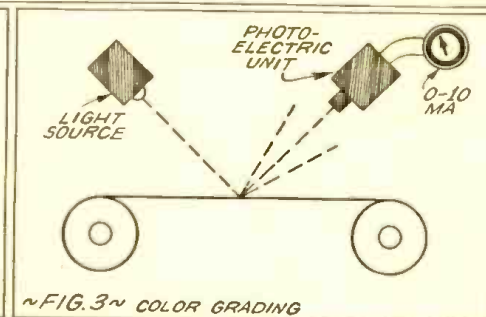
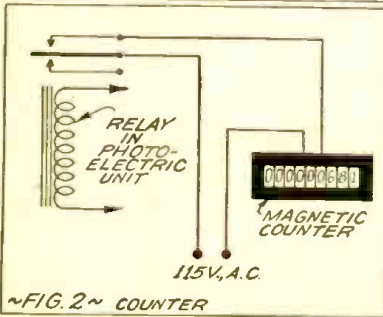
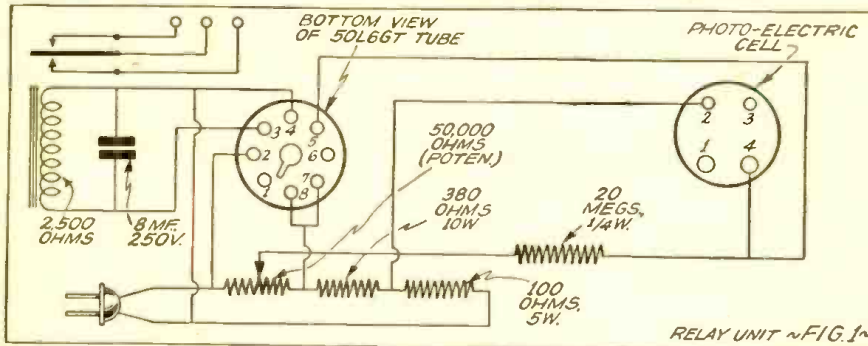

**NEW
HAMMARLUND
SHORT WAVE
MANUAL**

JUST OFF THE PRESS

- TRANSMITTERS**
- EXCITERS**
- RECEIVERS**
- POWER SUPPLIES**
- ANTENNAS**
- MODULATORS**

EVERYTHING for the Amateur and the Experimenter will be found in this valuable little book. Its 32 pages are crammed with valuable information on constructing and operating short-wave transmitting and receiving apparatus. Written in simple language, the new Short Wave Manual will appeal to the beginner and old-timer alike. If your dealer doesn't have the new manual in stock, send coupon below, with ten cents (coin or stamps) to cover mailing and your copy will be sent by return mail.

GET YOUR COPY TODAY!

HAMMARLUND MFG. CO., Inc. RT-11
424 W. 33 St., N. Y. City

Enclosed find 10c to cover mailing costs of manual.

Name
Address
City State



Canadian Office: 41 West Ave. No., Hamilton, Ont.

Modernizing

A TEST SET

E. A. GRAVES

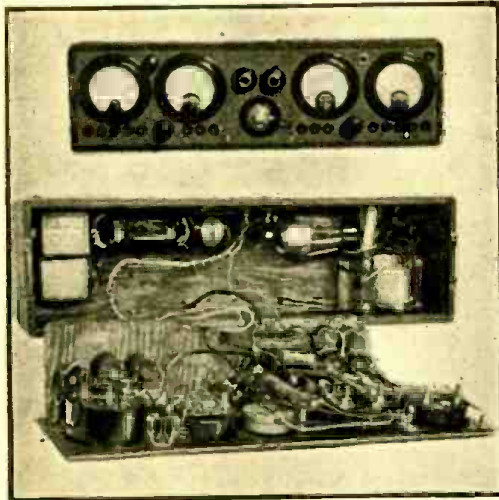

Left—The general appearance of the "modernized" test set is shown in the photographs—a neat and effective job.

Many Service Men do not find it possible to invest in new test instruments, and the author here describes how to modernize an old Supreme "Diagnometer." This instrument, after being rebuilt as here described, permits all of the usual tests being made on sets.

jacks of the 400-B on the panel for this purpose. The analyzer had featured numerous switch-jacks in which a plug was inserted, in order to throw the various ranges of the instruments into the analyzer plug circuit. Only one of these switchjacks was retained.

circuit diagram of the 400-B; but a little experimentation with the galvanometer in an ohmmeter circuit revealed which wire-wound resistors were in the circuit of the A.C. voltmeter, and what their approximate value was. The circuit of the A.C. voltmeter is shown in Fig. 1 (the resistance values are only approximate; each one of these meters has its resistors especially calibrated at the factory). I decided to place the voltmeter on the panel with five pin jacks, as shown.

THIS is the story of how an old Supreme Model 400-B Diagnometer was rebuilt into a modern multi-purpose test set. While thousands of these excellent old test sets must still be extant and waiting to be modernized, it is hoped that several small matters touched upon will be of interest to readers desiring to modernize other test sets, or to construct a test set from odd parts.

The Model 400-B was a rather elaborate set analyzer built around an A.C. Voltmeter, D.C. Voltmeter, and D.C. Milliammeter. Though more expensive to buy, an instrument having several meters is to be preferred to a single, all-purpose meter. The meters are less likely to be damaged in use, and also it is sometimes desirable to measure two or more quantities at once. It was with this in mind that my eyes fell greedily upon the three Weston meters in the panel of the old 400-B. It immediately developed that the D.C. voltmeter did not function on any range. By connecting a galvanometer, which I already possessed, in parallel with it, it was demonstrated that the meter itself indicated current flow properly, and the trouble was soon discovered. One end of the low range resistor was burned or broken loose from its connecting lug, and had to be scraped and resoldered.

The diagnometer, of ancient vintage, was rigidly designed and built for use as a plug-in analyzer of sets using the old four and five prong tubes, and could only be used with difficulty as a general purpose instrument. Study of the extremely involved circuit diagram, and of the instrument itself (the wiring of which was in cable form, and plenty hard to follow), led me to decide I wanted no part of an attempt simply to revamp it. Finally I cut the wires, took every part out, unsoldered all connections, and laid the parts out on a table. The galvanometer previously mentioned was taken out of its case and placed there too; it was desired to use the galvanometer as the balance indicator of a slide-back V.T. Voltmeter, and to build it with the other instruments into the oak case of the 400-B.

Previous experience with multiple purpose instruments had led me to dislike the multi-pole switch as a means of changing ranges, and I determined to place the pin

A.C. VOLTMETER

The A.C. voltmeter is of the moving-van type. Although it draws considerable current, it is an excellent and reliable instrument for measuring line and filament voltages, voltages at the various transformer taps, etc. By this time I had long since given up trying to discover the circuits of the various instruments by following the

D.C. MILLIAMMETER

The milliammeter is designed to give full scale deflection with a current of 25 mils. (ma.). Through a more sensitive meter would be better, I have found it quite satisfactory; the circuit of the D.C. voltmeter is arranged so that instrument may be used to give full-scale deflection on a current of one mil. The arrangement of the milliammeter is shown in Fig. 2.

Wiring diagram of the modernized test set as worked out by the author.

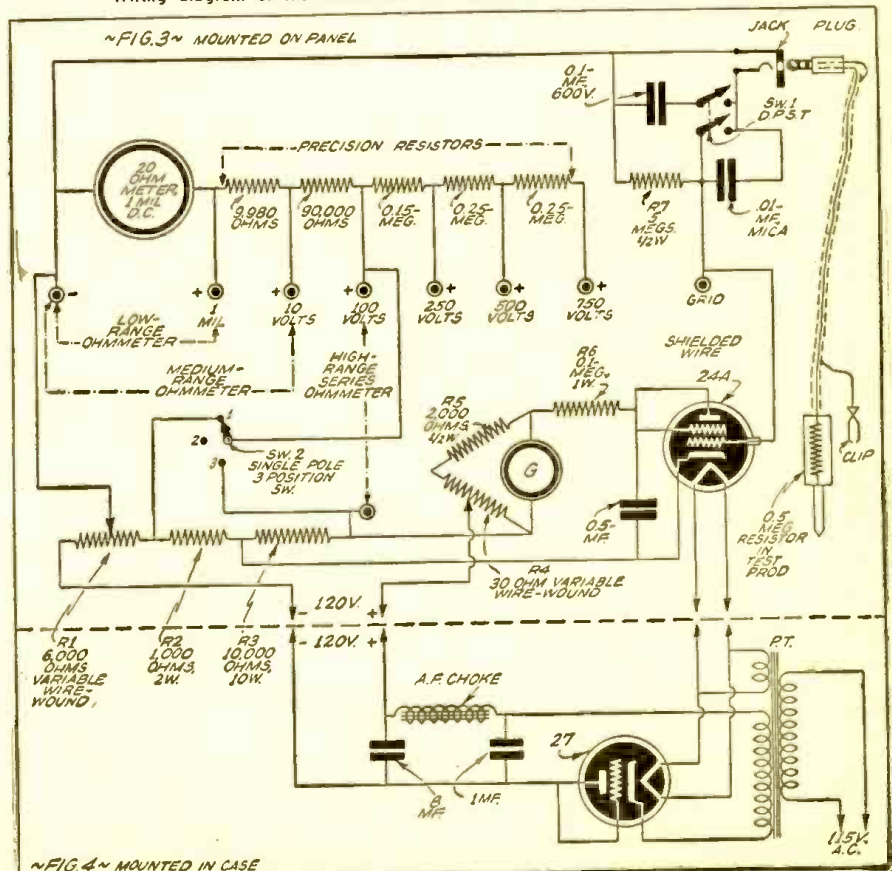

OHMMETER CIRCUIT

It was desired to use the D.C. voltmeter with the galvanometer to form a slide-back A.C.-D.C. V.T. voltmeter, but it was necessary that this should not interfere with the use of the D.C. voltmeter for its normal function. Moreover, it was desired to use the D.C. voltmeter as an *ohmmeter*, a function it had not previously performed. Also, it was necessary to build into the set a power-supply which would supply the ohmmeter as well as the V.T. voltmeter. Tubes, transformer, choke, condensers, meters, etc., would all have to go into the original case, together with the voltmeter and milliammeter already described. The voltmeter, ohmmeter, and V.T. voltmeter circuits were worked out as shown in Fig. 3.

The *ohmmeter* circuit has three ranges: Low, center-scale equals 20 ohms; medium, center-scale equals 10,000 ohms; and high, center-scale equals 0.1 megohm. As the meter scale is not calibrated in ohms, a table was prepared having four columns, the first giving meter readings from 1 to 100, and the other three giving the corresponding ohms for each of the three ranges. The first two ranges are "parallel ohmmeter" circuits, and as the resistances to be measured are thrown in parallel with (1), the twenty-ohm meter, or (2), the 10,000 ohm resistor of the 10 volt scale, the numbers in the first two "ohms" columns were determined by use of the formulae (1)

$$R_x = 20 \frac{\text{reading}}{100 - \text{reading}} \quad \text{and (2)}$$

$$R_x = 10,000 \frac{\text{reading}}{100 - \text{reading}}$$

The third range is a "series ohmmeter" circuit; in this case the resistance to be measured is thrown in series with the 100 volt supply, the 100,000 ohm resistor of the voltmeter, and the 1 ma. meter. The "ohms" values in the high range column were determined by use of the formula

$$R_x = 100,000 \frac{100 - \text{reading}}{\text{reading}}$$

In practice the ohmmeter is used as follows: Sw. 2 is thrown to position 3, and R_1 is adjusted for full scale deflection of the meter. For low and medium ranges, the resistor to be measured is connected across the meter, or the 10 volt range, respectively, and the reading on the 100 scale noted. A glance at the table (which has been glued on the side of the case) reveals the corresponding ohms resistance. For the high resistance range, the adjustment to full scale deflection is made as before; Sw. 2 is then thrown back to position 2, and the resistance to be measured is connected across the pin jacks provided for this purpose. By approaching to within 5% of scale length to the end of the scale, readings from 1 ohm to 2 megohms may be made. Ohmmeter accuracy depends on the same factors as does voltmeter accuracy, but also it becomes rapidly more difficult to read the ohmmeter properly as departure is made from center-scale. On this basis, this should be a more than ordinarily accurate ohmmeter.

SLIDE-BACK V.T. VOLTMETER

If you like the slide-back type of V.T. voltmeter this circuit may please you. It will be noted that R_1 , the zero-adjustment resistor of the ohmmeter circuit, also serves to supply the balancing voltage to the grid in the V.T. voltmeter circuit. With Sw. 2 in position 1, the balancing voltage applied

10,859 SET MODELS USE CONTROL TYPES INCLUDED IN THIS CABINET

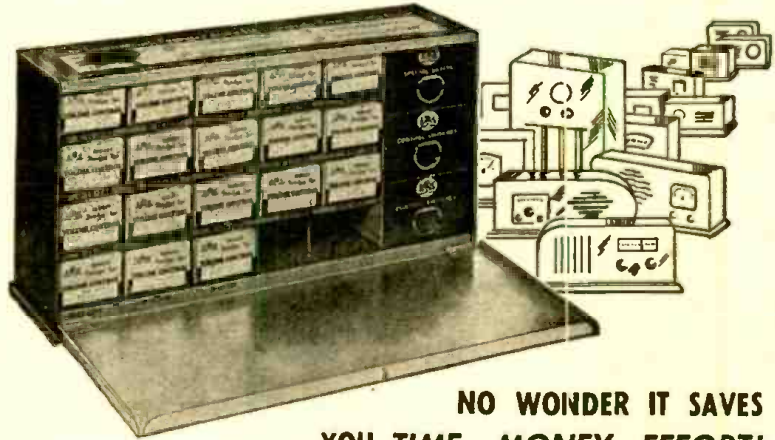

NO WONDER IT SAVES YOU TIME..MONEY..EFFORT!

By ACTUAL COUNT, 10,859 of the radio receiver models listed in the new IRC Volume Control Replacement Manual (Edition No. 3) call for one or more replacements that can be supplied from the 18 Type D Universal Controls, 6 switches and 5 extra Tap-in Shafts included in the IRC Control Cabinet. In other words, Cabinet owners are equipped for fast, accurate control replacement service on as high as 75% of all radio sets they are likely to be called upon to repair—and that isn't all!

Thanks to Tap-in Shafts, you can often use standard controls instead of more costly special replacements. What's more, Tap-in Shafts simplify installations, especially in crowded chasses where they avoid removing other parts in order to insert the control. And remember! Type D Universal Controls themselves are small enough to fit in anywhere—large enough for utmost dependability.

ASK YOUR JOBBER FOR THIS MANUAL!

If you haven't already received your copy of the new IRC Volume Control Replacement Manual (Edition No. 3) ask your IRC jobber today. It's a "must" for every serviceman who makes volume control replacements. Larger—more accurate—easier to use—contains more information and 35% more listings than ever before.



INTERNATIONAL RESISTANCE CO.

401 N. Broad Street, Philadelphia, Pa.

Headset Headquarters



Scientifically built Heavy bar magnets greatly increase their efficiency.

CANNON-BALL

Headsets are beautifully designed, light in weight, efficient. Guaranteed to reproduce with clarity and good volume. Write for folder T-28 illustrating complete Cannon-Ball Line.

C. F. CANNON COMPANY
SPRINGWATER, N. Y.

110 VOLTS A.C.

ANYTIME!
ANYWHERE!
WITH
KATOLIGHT PLANTS



Have special plant for operating portable radio receivers and transmitters. Close voltage regulation. FILTERED AND SHIELDED. 400 WATT AC AMATEUR'S PRICES

\$72.75

Other sizes up to 10,000 watts. Also converters, AC & DC generators. Diesels and frequency changers.

KATOLIGHT "Ask Your Jobber"
1 EL ST., MANKATO, MINN. U.S.A.

4,000 Plays
as nationally advertised

\$1.00

A true gem of a needle for the discriminating listener, guaranteed for 4000 perfect plays! Made of newly developed precious alloy; works fine with record-changers; uniform hi-fidelity.



DUOTONE COMPANY, Inc.,



All Duotone needles on sale at all dealers. If your dealer does not have them in stock order direct.

Jobbers! Write for circular describing complete line with prices and discounts.

Dept. R

799 Broadway, New York, N. Y.

Filter Point

as nationally advertised

35 for 25c

Minimum surface noise and little record wear; 15 perfect plays per needle, and no breaking on automatic changers! Polished point; hi-fidelity assured. Be sure to try them . . . NOW.



Built for
PUNISHMENT



Popular Supreme Model 542 and Model 543 in a Blitzkrieg dress—used by the army—and telephone companies—where hard knocks are the rule rather than the exception. **Built for Punishment.** Heavy steel cover protects meter—snaps into place. Full protection without the inconvenience of the old style lid. Large, sturdy leather handle, but still small enough to slip in your pocket. Size 3½" x 6¼" x 2¾". Wt. 2 lbs. 2 oz. See your jobber or Write Dept. RC-8 for information.

Notice—Model 542-543 Supreme Owners. You can secure this new type case for your present instrument at the small cost of \$2.25.

SUPREME

GREENWOOD, MISSISSIPPI, U. S. A.

by R₁ may be read on the D.C. voltmeter. The V.T. voltmeter is used as follows: With Sw. 2 in position 1, and with R₁ set to zero, the galvanometer is balanced by means of R₂. Test prods are applied to the voltage to be measured, and R₁ is adjusted to bring the galvanometer back to zero; the value of the balancing voltage may then be read on the D.C. voltmeter.

In the V.T. voltmeter circuit, Sw. 1 is a D.P.S.T. switch used for changing the input circuit for use on A.C. or D.C. This switch is in the circuit of the jack which gives access to the V.T. voltmeter input by means of plug and shielded cable. It should be noted that if the V.T. voltmeter is used in this way, the shielded cable tends to capacitatively short out R.F. voltages, and A.C. voltages of audio frequency only can be measured in this way. Also, for D.C. voltages, the test prod, which connects to the grid of the 24A, must be applied to the positive side of the voltages to be measured; this is because the balancing voltage is in the form of a negative grid bias, and can only be used to balance a positive voltage.

As the diagram shows, access to the V.T. voltmeter may also be had by means of ordinary test cords. The "tube on cable" method may also be used. A very good arrangement for this was given in the August, 1941 issue of *Radio-Craft*, and a suitable circuit is shown in Fig. 5.

The balancing circuit is a simple bridge, in which R₁ is the 30 ohm rheostat of the old 400-B converted for use as a potentiometer. The galvanometer gives full scale deflection on a current of 660 microamperes. A 1 ma. meter would serve just about as well. If a 1 ma. meter were used, the 0.1 megohm resistor, R₂, in the plate circuit of the 24A, could be reduced in value somewhat, so as to give equal sensitivity. This resistor reduces the sensitivity of the circuit somewhat but serves to limit the plate current to a value such that the plate circuit meter cannot be injured.

Whether the slide-hack type of V.T. voltmeter is better or worse than other types, depends largely on the use to which the meter is put. The slide-back type is accurate, it has no calibration to maintain, and it has the advantage of measuring peak A.C. volts as well as D.C. volts. In this application, sensitivity is limited to voltages that can be read on the 100 volt scale of the D.C. voltmeter. The maximum range is about 40 volts; however, the range could be extended by changing the value of R₁, so as to allow a greater range of adjustment of the balancing voltage. Also, if a 5 megohm resistance is inserted in the lead to the grid of 24A, the voltage measured will be double the reading obtained.

The power supply for this unit should

furnish 2.5 volts for filaments, and approximately 120 volts D.C. This voltage is not critical, and need only be such that R₁ can set the ohmmeter voltage to 100 volts. However, good regulation is essential, as in most instrument power supplies. Also, a transformer type power-supply is necessary in order to avoid accidental injury to meters, etc., through shorting to the power line.

Bringing out heavy, insulated wire for the leads, and fastening it on securely so as not to depend on the fine wire for its support, a high voltage secondary of fine enameled wire (taken from an old choke coil) was wound on by hand. One hundred turns were wound to the layer, and these were wound in groups of ten, so that no two turns in which a considerable difference of potential existed, would be in proximity. Between layers, a thin piece of paper, stuck on with shellac, and covered with the same liquid, was placed. 900 turns were used to give 150 volts A.C.; there is considerable loss in the winding, in the tube (27) used as a rectifier, and in the filter circuit, which has a very low capacity input.

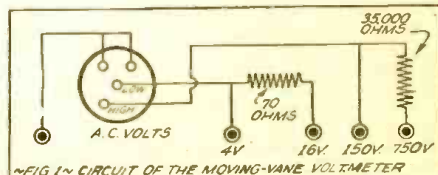

FIG. 1~ CIRCUIT OF THE MOVING-VANE VOLTMETER

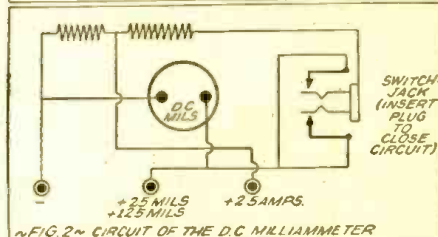

FIG. 2~ CIRCUIT OF THE D.C. MILLIAMMETER

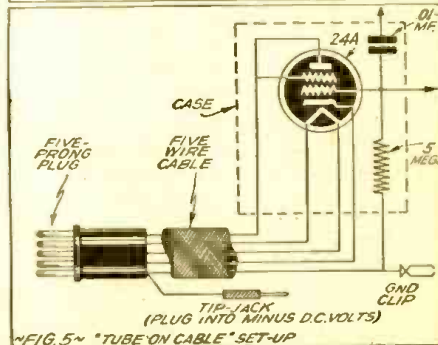

FIG. 5~ "TUBE ON CABLE" SET-UP

Circuits of the test meters and cable set-up.

**MODERN PARTS for
MODERN CIRCUITS**

THAT HAVE BEEN

*"Designed for
Application"*

CATALOG UPON REQUEST

JAMES MILLEN MFG. CO. INC.
150 EXCHANGE ST. MALDEN, MASS.

OPPORTUNITY AD-LETS

Advertisements in this section cost 15 cents a word for each insertion. Name, address and initials must be included at the above rate. Cash should accompany all classified advertisements unless placed by an accredited advertising agency. No advertisement for less than ten words accepted. Ten percent discount six issues, twenty percent for twelve issues. Objectionable or misleading advertisements not accepted. Advertisements for January, 1942, issue must reach us not later than November 25, 1941.

Radio-Craft • 25 W. B'way • New York, N. Y.

EDUCATIONAL COURSES

CORRESPONDENCE COURSES AND EDUCATIONAL books, slightly used. Sold, Rented, Exchanged. All subjects. Satisfaction guaranteed. Cash paid for used courses. Complete details and bargain catalog FREE. Write Nelson Company, 500 Sherman, Dept. L-242, Chicago.

FLUORESCENT LIGHTING

24" FLUORESCENT BENCH LIGHT \$1.49, LESS TUBE.
Harold Davis, Jackson, Mississippi.

INSTRUCTION

DRAFT HAS OPENED RADIO ANNOUNCING FOR you! Network announcer writes honest details. Getting and holding job. Mike technique. Transcriptions. Procedure. Everything! Twenty mimeographed pages of price-less instruction, \$1. Box 460, Elmira, N. Y.

RADIO

USED TECHNICAL COURSES AND BOOKS BOUGHT. Sold, Rented, Catalog Free. Vernon Educational Exchange, Summerville, Ga.

**MATHEMATICS
FOR RADIO
AND COMMUNICATION**

by **GEORGE F. MAEDEL, A.B., E.E.**
Chief Instructor, N.Y. School, RCA Institutes

To master the technicalities of radio—to read engineering literature intelligently—you must have the mathematical groundwork covered by these absorbing books prepared for home study. Book I (314 pp.) covers the algebra, arithmetic, and geometry; Book II (329 pp.) covers the advanced algebra, trigonometry, and complex numbers; necessary to read technical books and articles on radio.

MAEDEL PUBLISHING HOUSE Room 117
593 East 38 Street, Brooklyn, New York

Send me Mathematics for Radio and Communication as checked below. I enclose payment therefor with the understanding that I may return the book(s) within 5 days in good condition and my money will be refunded.

Name
Address

- Book I at \$3.75 plus 3c postage
- Book II at \$4.00 plus 3c postage
- Books I and II at \$7.75 postage prepaid



The New RCA Model R-560-P

Six New Radiola Models

• A NEW series of 1942 Radiolas consisting of four A.C.-D.C. table models, a phonograph-radio Electrola, and a battery-powered farm radio, has been announced. These new instruments are in addition to a number of Radiola models recently announced.

The four new A.C.-D.C. table models, two of which are 2-band instruments, have improved 5-tube superheterodyne chassis, and have outstanding performance features. They are housed in smartly styled cabinets, two of plastics and two of matched woods.

Approved by Fire Underwriters, the new instruments employ a 5-inch dynamic loudspeaker, magnetite-core I.F. transformers for improved sensitivity, plug-in connection for record player attachment, built-in antennas, and many other features. Newly-styled clear vision dials make tuning unusually easy for such compact table models.

Model 516 of the series is encased in a rich brown plastic cabinet of modern design, with a convenient carrying handle on the top. Like all the other new models, the straight-line dial is on the "nose" of the cabinet. The grill opening is hidden behind vertical louvre openings. Tuning and control knobs are large and easily handled.

Model 517 is somewhat similar in style and appearance, except that the cabinet is of selected veneers. The grill louvres cross the front of the cabinet for almost its entire width, lending an unusual style note.

Model 526 is a two-band instrument with a new station-spreader dial that "spreads out" the 25- and 31-meter foreign bands for greatly simplified tuning of short-wave broadcasts, a feature heretofore confined to higher priced instruments. The cabinet is the same as that employed by the Model 516.

Model 527 is similar to Model 526 in operating features and the station-spreader dial, but is housed in a two-tone wood cabinet of selected veneers.

The new Electrola, Model R-560P, provides both first class radio entertainment and the world of enjoyment to be found in recorded music. The phonograph-radio provides excellent quality by the use of a specially designed audio circuit and a highly efficient dynamic loudspeaker. Either 10- or 12-inch records may be played with the lid closed. Five tubes are employed. The cabinet is of selected walnut and birch veneers, blended into a simplified, attractive styling.

The new farm model Radiola is designated as Model B-50. Low drain tubes assure low operating costs, while the superheterodyne circuit is highly selective and sensitive. An automatic volume control reduces blasting and fading. The cabinet, of walnut veneer, is styled to blend with practically any type of surroundings, and is designed to contain the batteries.

Knob Puller

• THE General Cement Mfg. Co. announces a very simple, low-price radio knob-puller. It somewhat resembles the wire insulation scraper with which radio men are familiar. This knob-puller will save a lot of time on the part of radio experimenters and service men and should be included in every tool kit.

New Stromberg-Carlson FM Features

• HIGHLIGHTED by two unique FM engineering developments, the 1942 line of the Stromberg-Carlson Tel. Mfg. Company will be introduced shortly.

The developments, incorporated in FM radios for the first time in the history of the industry are automatic "range shifting" and a simplified push-button control for both FM and standard broadcasting. Both developments were pioneered by the Stromberg-Carlson laboratories in Rochester, one of the most complete acoustical laboratories in the world.

The new line shows a strong emphasis on "frequency modulation" receivers. It is expected that 80% of the company's volume during the coming season will be in FM radios.

Four new chassis and twenty-six models are included in the 1942 line. Low priced receivers appear in two-tone plastics, with consoles and radio phonographs in highly figured walnuts and mahoganies.

**Another New Display
to Add to Our Big
List of Sales Helps**



MARK UP ONE for the Sylvania Advertising Department. When Rosemary La Planche was named Miss California, she was picked for our big Football window display. Months afterward, on September 7, she was named Miss America. So the Sylvania Radio Serviceman's window display this Fall is a portrait of Miss America. Other Sales Helps by the dozen are yours FREE or at a modest cost. Get full information and samples of what you may want by writing Hygrade Sylvania Corp., Dept. RC12, Emporium, Pa. Write today before you forget.

Sylvania Helps You Sell—See Below

- | | |
|---|--|
| 1. Miss America Football Window Display | 16. Technical manual |
| 2. Counter displays | 17. Tube base charts |
| 3. Electric Clock signs | 18. Price cards |
| 4. Electric Window signs | 19. Sylvania News Characteristics Sheets |
| 5. Out-door metal signs | 21. Interchangeable tube charts |
| 6. Window cards | 22. Tube complement books |
| 7. Personalized postal cards | 23. Floor model cabinet |
| 8. Imprinted match books | 24. Large and small service carrying kits |
| 9. Imprinted tube stickers | 25. Customer card index files |
| 10. Business cards | 26. Service Garments |
| 11. Doorknob hangers | 27. 3-in-1 business forms |
| 12. Newspaper mats | 28. Job record cards (with customer receipt) |
| 13. Store stationery | |
| 14. Billheads | |
| 15. Service hints booklets | |

SYLVANIA

SET-TESTED RADIO TUBES

Also makers of Hygrade Lamp Bulbs, Hygrade Fluorescent Lamps, and Miralume Fluorescent Light Fixtures

• TO ALL YOUNG MEN OF AMERICA •

Today, as never before, trained radio men are in great demand not only for service in the armed forces of Uncle Sam, but in many branches of industry such as the Air Transport and Broadcast Industries. Midland training, supervised by instructors released to us by major Airlines and directed by a nine Airline Advisory Board, offers sound employment opportunities to the foresighted, ambitious man. The demand for our qualified students far exceeds the supply.

FREE CATALOG AND MAGAZINE

Investigate the benefits of Midland Airline Radio training without delay. Send for your free copy of our profusely illustrated and colorful fifty-eight page catalog and training outline. A copy of Midland News containing many articles that will be of interest to you will be included. Find out for yourself what other men have accomplished through Midland career training.

MIDLAND RADIO and Television SCHOOLS, INC.

Dept. MR-10

Power and Light Building

Kansas City, Missouri



WRITE TODAY!

DON'T DELAY!



CHASSIS CABINETS RACKS PANELS

BY PAR-METAL

"For Quality and Beauty"

Whether you want a "standard" job or a De Luxe job—you'll find that every Par-Metal part has been accurately machined for easy assembly and smartly designed to give the finished job the look of commercially produced equipment.

New Catalog No. 41 Send on Request

PAR-METAL PRODUCTS CORP.

3262 49th St., Long Island City, N. Y.
Export Dept.: 100 Varick St., N. Y., N. Y., U.S.A.

Improved Phono-Amplifier

• WEBSTER-RAULAND'S new phono amplifier is designed to give better reproduction from phonograph records. Automatic volume expansion permits true fidelity expression of voice and music as recorded, particularly in bringing out the crescendo of the fuller passages and the diminuendo of the softer tones. The unit is designed with vertical front panel and within specified dimensions to permit rack mounting if so desired. Incorporates such features as: automatic volume expander up to 10 db.; dual fader-phono unit (permitting mixing and fading of two phonos); two separate tone controls, each increases or decreases treble and bass respectively, and master volume control with A.C. switch.

20 Watt "Bantam" Portable P.A.

• A CHICAGO concern has introduced an improved 20-watt compact sound system that is exceptionally lightweight and ingeniously portable. Scientific sound research has at last produced a "Bantam" unit with excellent distributed weight-balance, simplicity of design and operation, and elimination of speaker case rattling.

It is easy to carry, easy to set up and use—with all the power needed for most performance. Schools, orchestras, carnivals, lecturers, and demonstrators will readily appreciate the remarkable and practical flexibility contained in a unit no larger than an average suitcase.

The complete Allied Radio Corp. "Bantam" portable includes: 1 special 20-watt amplifier with tubes and built-in phono; 1 Shure crystal P.A. mike with 25-foot cable on desk stand; 2 10" elliptical speakers with 25-foot cables and plugs attached; complete instructions. It's housed in the most compact case available today; finished in brown air-luggage cloth; size 24" x 10 3/4" x 10 3/4"; weighs only 40 lbs.

The rugged amplifier with phono top is housed in the center section of the case. It has 20 watts usable power output (26 watts peak); hum is inaudible (55 db. below rated output). Output impedance, 4 and 8 ohms; supplies field excitation for two 2500-ohm speakers. Has three input channels, one for high-gain mike with individual control, two for phono with fader. Includes bass-treble tone control. Gain on mike is 127 db.; on phono, 70 db. Frequency response is 50-10,000 CPS. Tubes used are: 1 6SJ7, 1 6SC7, 1 5Y4, 2 6L6. Line drain is 160 watts. Fully fused for operation from 110-120 volts, 60 cycles A.C. E.R.P.I. licensed.

New 14-Tube "FM-AM" Phono-Radio Combination

• HOWARD RADIO COMPANY announces a powerful new 14-tube FM-AM phono-radio combination, Victory Model 718FM-C. Tunes four bands—FM, AM, and two "short-wave" bands. Has three-gang tuning condensers, tuning eye, special 12" Jensen Speaker, tuned RF on broadcast band, and bass and treble tone control. Push-pull 6V6 beam power output—10 watts. Efficient automatic record changer has light-weight pickup. Set is housed in richly finished Chippendale Period Cabinet. Has compartment for albums. Measures 37 1/2" high, 35" wide, 8 1/4" deep.



Noise Suppressor

• A NEW item has been added to the Solar line of "Elim-O-Stat" radio-noise-suppressors. It is known as the type AFL and is specifically designed to eliminate radio interference created by fluorescent lighting equipment. It is supplied in a small, narrow metal case for channel mounting.

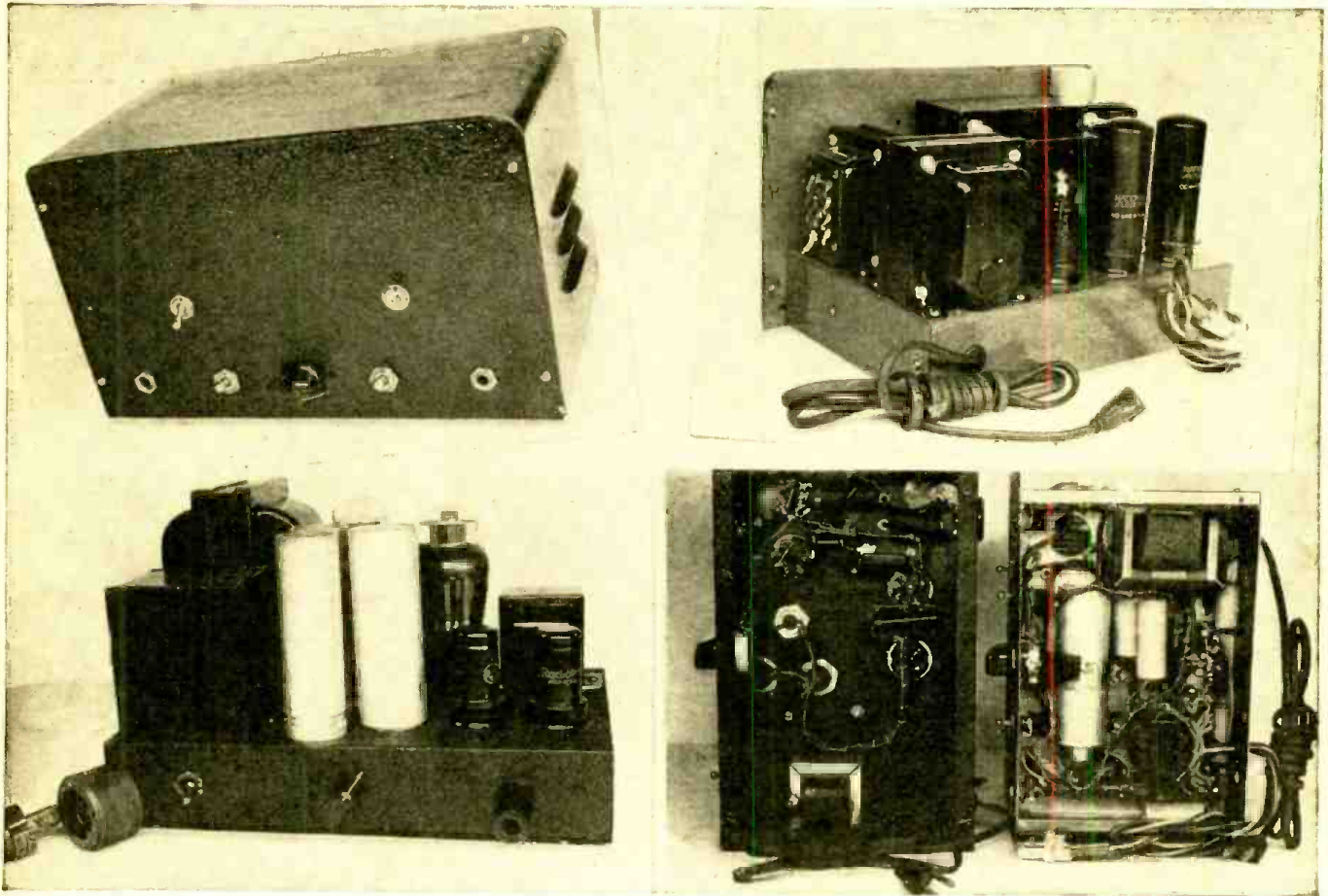

1—Top left—The renovated Stancor 10P cabinet makes this excellent housing for modulator B.
 2—Top right—A rear view of Modulator B. Note power connector for high voltage.
 3—Lower left—Modulator A showing extremely simple construction.
 4—Lower right—Bottom view of both modulators. Unit B on the left.

Grid-Modulating the

Compact Kilowatt Xmitter

Larry LeKashman, W2IOP

● THE compact kilowatt (RADIO & TELEVISION for April, 1941) utilizing 813's was first introduced to show the tremendous possibilities of high-power beam-power tubes. Primarily a CW transmitter, the 813's offer medium-power phone operation by the simple expedient of adding a grid modulator.

The primary objection to grid modulated transmitters has been the idea that it is difficult to adjust. Following this we hear disparaging remarks about the low efficiency of grid-bias modulation as compared to plate and cathode modulation. While these complaints had some legitimate background prior to 1939, in *QST* for September, 1939, there appears an article entitled "Increased Output With Grid-Bias Modulation" by J. A. McCullough, W6CHE. This would not be the place to repeat a complete description of a system well covered already in Mr. McCullough's article. Since *QST* is available to every radio fan, if not on one's personal library shelf, we refer you to W6CHE's article for the background

The author describes how to apply grid modulation to the "Compact Kilowatt" transmitter described in the April issue of this magazine. Simplicity of construction and lower cost are features of the modulation system described.

necessary to handle the equipment covered in this description. There is no question that even the uninitiated could handle grid modulation, if the meat of the article referred to is absorbed.

To limit a grid modulator to any one transmitter is not sensible, in the light of the fact that each unit will find many applications. Consequently the modulators described will find applications in more than the 813 type transmitter. Plate modulation of the compact kilowatt would obviously have defeated the small size of the transmitter and—in addition—is costly for high

power. Modulation of the screens would also be necessary and unless handled with extreme care will cause poor quality and low audio efficiency. Cathode modulation still requires in the neighborhood of 80 watts of audio which, if not fairly high priced, would still be quite large.

The simplicity of construction is an outstanding argument for proponents of grid modulation and concurrently low-price gear is made possible. Modulator A comprises a 6SJ7 resistance-coupled to a 6C5, resistance-coupled to a 6L6. This supplies all the audio required to grid-bias modulate the 813's at full input. The relatively few components are mounted on a 7 x 11 chassis. Since phone operation at this particular installation was not a regular procedure, no attempt was made to beautify the equipment other than doing a neat job. As a matter of fact, the modulator is kept in a drawer and only brought out when phone operation is desired. The second modulator, unit B, includes a substantial power-supply to operate a medium-power transmitter.

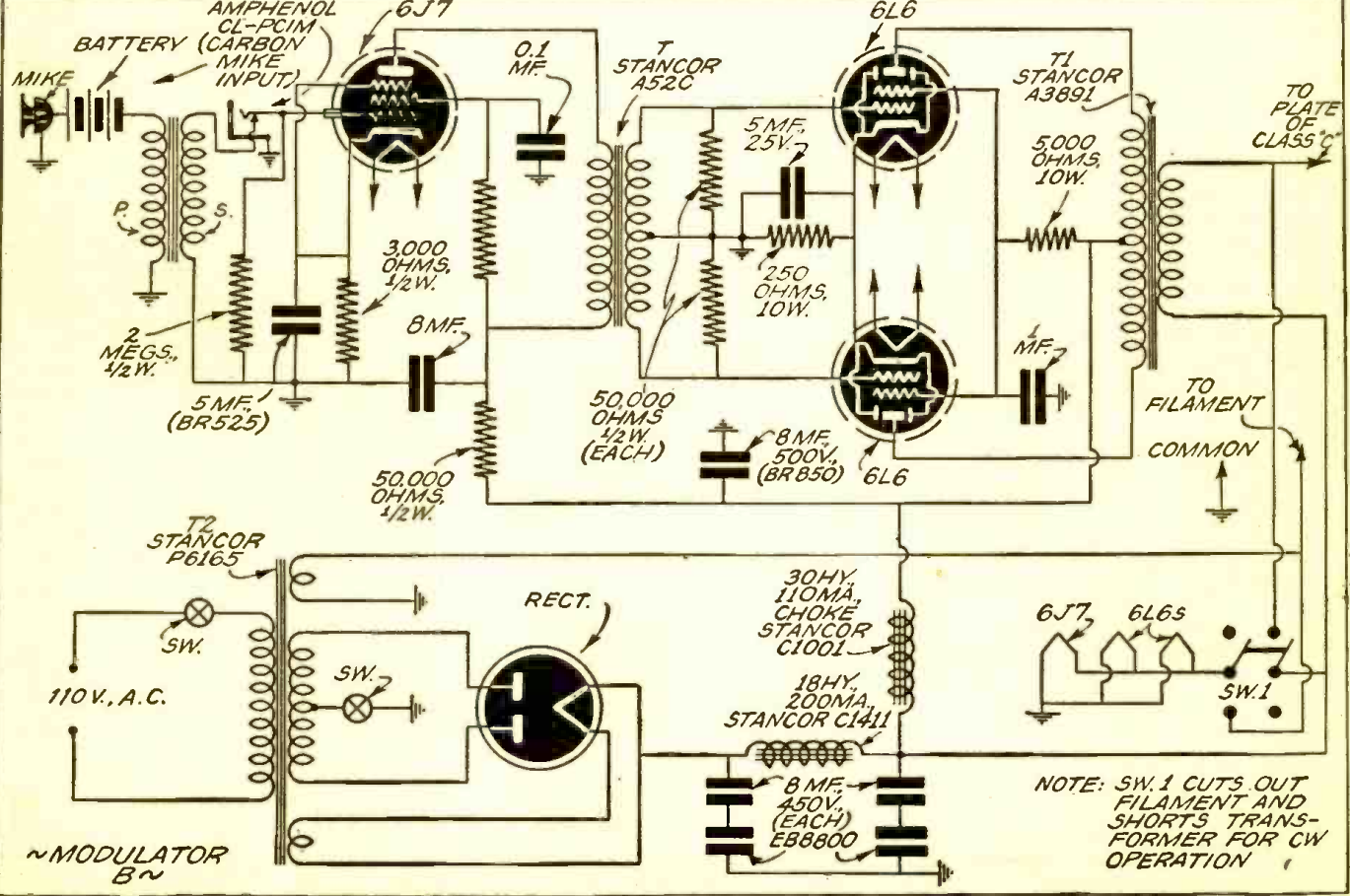
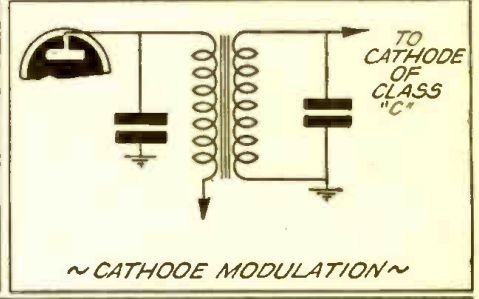
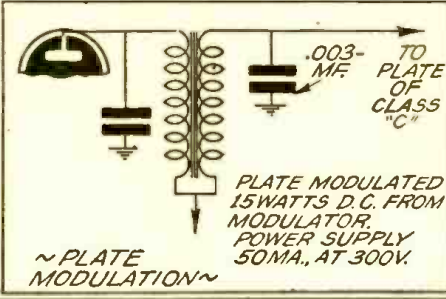
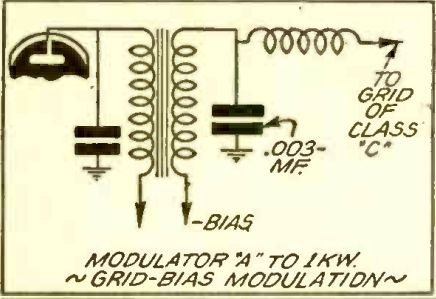
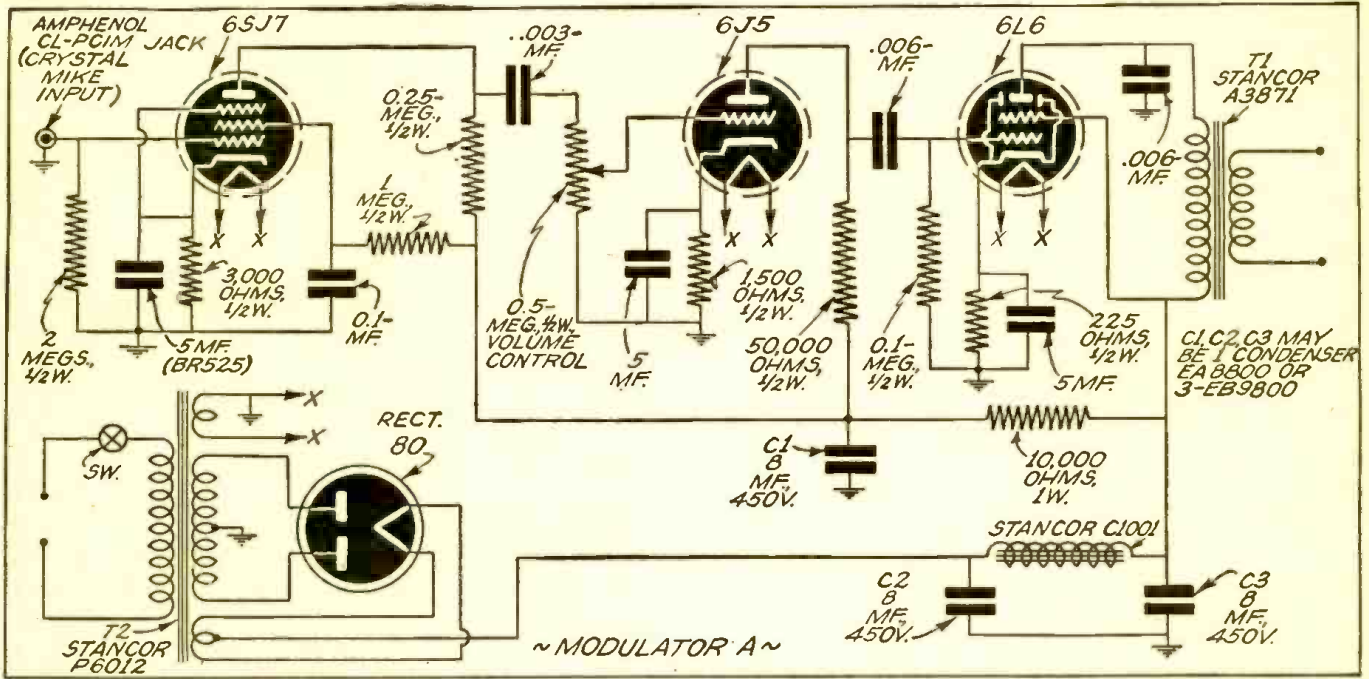

Wiring diagrams for the "A" and "B" modulators described in the text by Mr. LeKashman. The circuits have been tested by the author.

Modulator B is mounted on a Stancor 10P chassis and in a 10P cabinet. This eliminates most of the mechanical work, a front panel being the only constructional problem. The modulator is capable of the three types of service illustrated for Modulator A. The 6J7 resistance-coupled to a pair of 6L6's delivers somewhat more audio than the uncased modulator, because of the higher initial plate voltage. The power-supply is, in addition, large enough to supply plate voltage for tubes such as the HY69 or 807.

Included on the original model of the second unit is an additional switch, which makes it possible to cut out the power-supply and switch the filaments and plate connections directly to an Amphenol connector on the back of the chassis. For portable work, where battery power is used, this is extremely convenient. Filaments are taken directly from the storage battery and the

D.C. is "piped" in from the vibrator or motor-generator supply. A special cable with the necessary clips on the end is kept on hand at all times. This practical application of the modulator illustrates again the numerous advantages of unit construction. Of course there is an equal number of builders who will feel such innovations superfluous. It is our contention, though, that all amateurs should design equipment, wherever possible, with an eye to "emergency" service. For that reason, in future transmitting articles you will see a more prolific use of instantaneous heating filament tubes.

Modulator B in conjunction with any battery-operated transmitter of 20 to 40 watts will supply all the modulation necessary. While phone is not recommended in the field, there are times when lack of trained personnel makes its use necessary.

Prize READERS' EDITORIAL

THOSE "HAM" VERIS AGAIN!

● EVER since the first short wave listener tuned in an amateur radio station there has been an almost ceaseless argument over whether amateur station owners should verify reports of short wave listeners. And like all good arguments, this one has two sides. Many short wave fans believe that amateur station owners are a bunch of stuck-up, selfish, jealous prudes because they refuse to verify. Many amateurs believe that most short wave fans are silly, thoughtless and also selfish.

Amateur stations are operated "just for fun." The only income an amateur has is what he earns by his daily labor, or is given him by some rich uncle, which is seldom the case. He is not allowed to derive one

cent from his radio broadcasting. To ask such a person to dig down in his jeans for postage and cards is asking a bit too much. This is especially true of many stations that get out far and wide, as the number of requests for cards from such stations reaches a staggering amount. This same amateur knows where his signal is going, as he is told that by the stations he "works." He does not, like many broadcasting stations, have to depend on listeners' reports to determine if he is getting out. The reports of listeners are seldom of value to him, while they are of value to short wave broadcasting stations. Therefore, he should not be asked to pay the costs of verifying and he cannot spend money to write and tell the listener that he cannot verify. A short wave broadcasting station and an amateur station should be classified differently in regards to verifying. **NO LISTENER SHOULD CONDEMN AN AMATEUR FOR NOT VERIFYING UNLESS HE HAS SENT SOMETHING TO DEFRAY THE COSTS OF VERIFYING.** And he should not condemn all amateurs if he does send the price of a verification and gets nothing, because there are some bad amateurs the same as there are some bad church-members and you cannot close churches or condemn them for the few ineffective members they have.

On the "other side" are many listeners who delight only in collecting verifications rather than listening to radio broadcasting. It is without a doubt a most fascinating hobby and should be helped whenever possible. Collecting verifications broadens one's vision, creates a better understanding between the people of the world and brings one a feeling of accomplishment. And no one was ever hurt following this hobby.

Many listeners do not know the difference between a good report and a poor one. They do not know what an amateur would like to receive in the way of a report. Because of this, no amateur should condemn all listeners. Rather, he should, in his reply, explain to the listener what should have been written and then that listener will know what to send in his next report to an amateur. He should be told where he made his mistakes and how to correct them.

ARTHUR J. GREEN,
Pres. Int. Short Wave Club,
East Liverpool, Ohio.

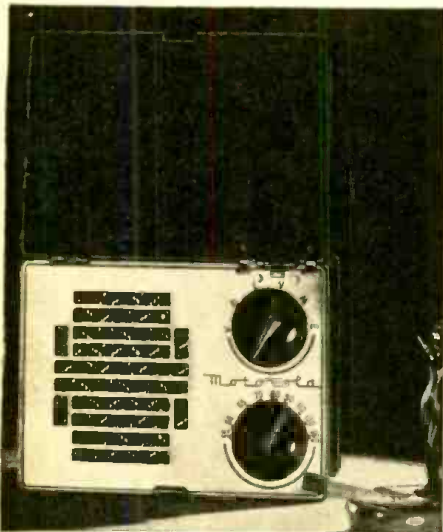

PRIZE SET FOR BEST EDITORIAL

This month the prize set awarded for the best readers' editorial is a Motorola Model A-1 "Playboy" Battery Portable. This is one of the finest personal sets the editors have seen; it is fitted with a self-contained loop antenna of special design. The tuning range is 550 to 1600 kilocycles. The set is fitted in a handsome metal case with chrome trim. It comprises a six tube superhet; the "A" batteries are standard flashlight cells, the "B" battery being a Minimax. An automatic switch turns on the set when the front cover containing the loop is opened. The set measures only 6 1/4 x 4 3/8 x 3 1/2 inches and weighs 4 1/4 lbs. complete. This set is awarded through the courtesy of the Galvin Mfg. Corp., Chicago, Illinois.

TO BUILD SPECIAL UNITS MORE EASILY



A DIAL DESIGNED FOR INDIVIDUAL CALIBRATION

TYPE ACN DIAL

- Dial bezel acts as drilling template.
- Blank scales for direct calibration.
- Index holes in pointer for pricking calibration points.
- Scale removable without dismantling mechanism.
- Employ Velvet Vernier Drive Unit.



A UNIT COMBINATION OF COIL AND CONDENSER

TYPE AR-16 COIL & TMK CONDENSER

- Plug-in coils fit swivel mount.
- Air-spaced coils or plain coil forms available.
- Low loss construction throughout.
- Rigid condenser frame for permanent calibration.
- Condenser mounts on panel, chassis or standoff insulators.
- Condenser capacities to 250 mmf.

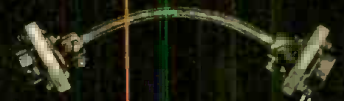

AN INSULATED COUPLING THAT WORKS AROUND CORNERS

TYPE TX-12

- Isolantite insulation.
- High quality flexible shafting.
- Fits 1/4" shafts.

NATIONAL COMPANY, INC.

MALDEN



MASS.

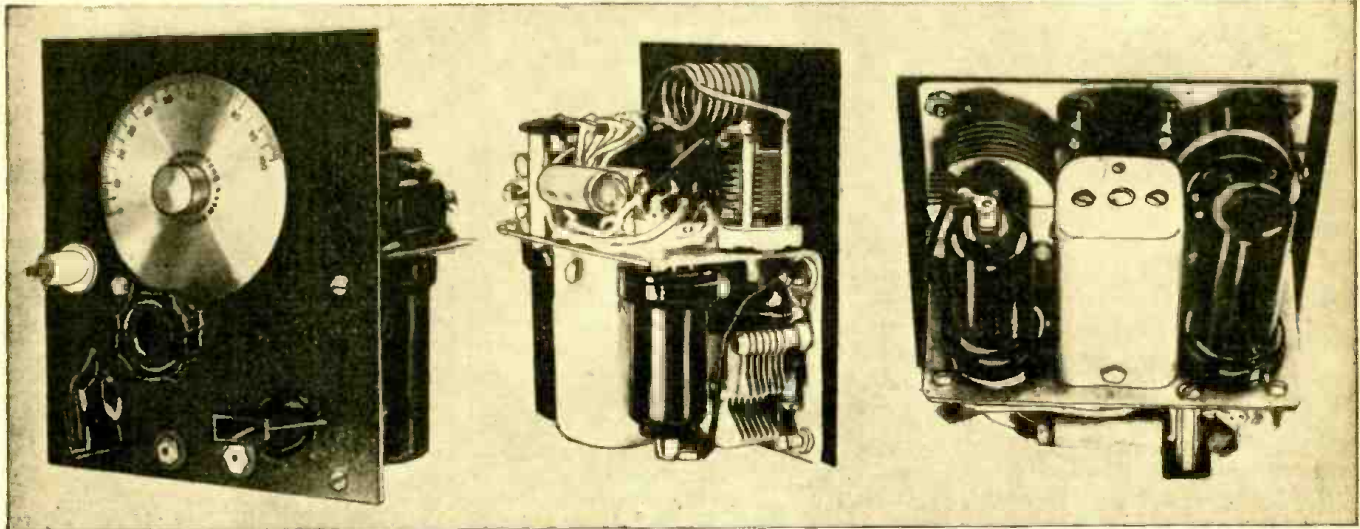

Left—Front view—Left-hand knob is the first detector tuning; right-hand knob controls the regeneration. Center—C1 and L1 are below shelf and C3 and L2 above. C2 is behind C3. Right—Below, Chassis view, showing placement of parts and tubes. Condenser is C1 (see diagram).

"Recei-Verter" — A Hi-Freq. Converter

Howard Burgess

This ingenious and useful converter may also be used as a superhet "receiver." It employs 3 tubes and may be operated from the power-supply in a receiver, or from an auxiliary source of current. Coil and condenser data are given for operation of the device on 10 meters.

● IN the past few years any number of high frequency converters have appeared in all of the radio publications. Most of these perform equally well, depending upon the care given in their construction, and are ideal for the fellow who cannot afford a communications receiver built for the higher frequency bands.

Since such a *converter* was under construction it was decided to add a second detector and an audio stage and thus make a full-fledged miniature superhet. It could then be used either as a *converter* or as a *complete receiver*. As the set was to be used only for *ten meter* work, no provisions were made for coil changing, which simplifies construction and allows much more compact mounting of parts.

Of course the two problems foremost in using such a gadget as a complete receiver would be the lack of selectivity and sensitivity generally gained in the intermediate stages of a receiver. In the final model these were overcome to a surprising degree. Examination of the diagram in figure 1 will almost tell the complete story. Two tubes are used, a 6K8 in the R.F. section and a 6N7 in the audio section.

The input circuit is very conventional and is tuned to the desired frequency range. The oscillator, also quite conventional, is tuned to a frequency approximately 1500 kilocycles lower or higher which means that the intermediate transformer must be of the 1500 kc. variety. This frequency was

chosen to reduce images as much as possible and still match a standard *broadcast* receiver for converter use. The output of the I.F. coil in turn feeds the detector which is one section of the 6N7. The second section which is used as a single stage of audio is resistance-coupled to the detector.

The intermediate transformer is perhaps the most important part of the entire set. This must be revamped. The grade of coils used and the care with which it is reworked, will be the direct answer to the problems of sensitivity and selectivity. An iron core I.F. should be used to take advantage of the added gain obtainable with one of these. One of the oldest methods known is used to get still added gain and selectivity. That is *controlled regeneration* in the detector circuit. By using a regenerative second detector, both selectivity and sensitivity can be controlled to a very great extent. With the regeneration completely off the gain of the receiver is greatly reduced. When set near the point of oscillation the tuning becomes quite sharp, and when pushed into continuous oscillation it forms a very good substitute *beat oscillator* for CW reception.

Revamping the I.F. Transformer

To revamp the I.F. transformer, first remove the coils from the shield can and trace the leads to find the input and output coils. Two more coils will have to be added to fill our purpose. Each of these will consist of ten turns of Litz or #28 silk or

cotton covered wire. One of these must be wound close to the input I.F. coil and the other will be wound beside the output coil. These should not be placed between the original coils but rather on the *outside*, toward each end of the dowel. The one wound close to the output coil will be the plate feed-back coil for detector regeneration. The other coil wound at the input will be used for *coupling* to a broadcast receiver when the unit is used as a converter. This coil is brought out to terminals which are left disconnected except for *converter* use. If the B.C. receiver has provisions for using a doublet antenna the link should be connected there. If not, one side is attached to the antenna post and the other lead grounded to the chassis.

The parts are mounted on a small shelf-type chassis attached to the panel in the form of an inverted "L". The shelf is bent from aluminum $5\frac{1}{4} \times 4\frac{1}{2}$ inches in size. The bend is made $2\frac{1}{2}$ inches from the end, leaving a shelf $2\frac{1}{2}$ " by $4\frac{1}{2}$ ". The two tubes and the I.F. coil are mounted inverted under the shelf. Also beneath the shelf are the first detector tuning condenser and coil, the regeneration control and the headset and antenna connections. Above the shelf are mounted the other parts which include the resistors, condensers and oscillator tuning circuit.

As the parts are mounted so compactly, any small change will affect the number of turns on the coils so it is almost impossible

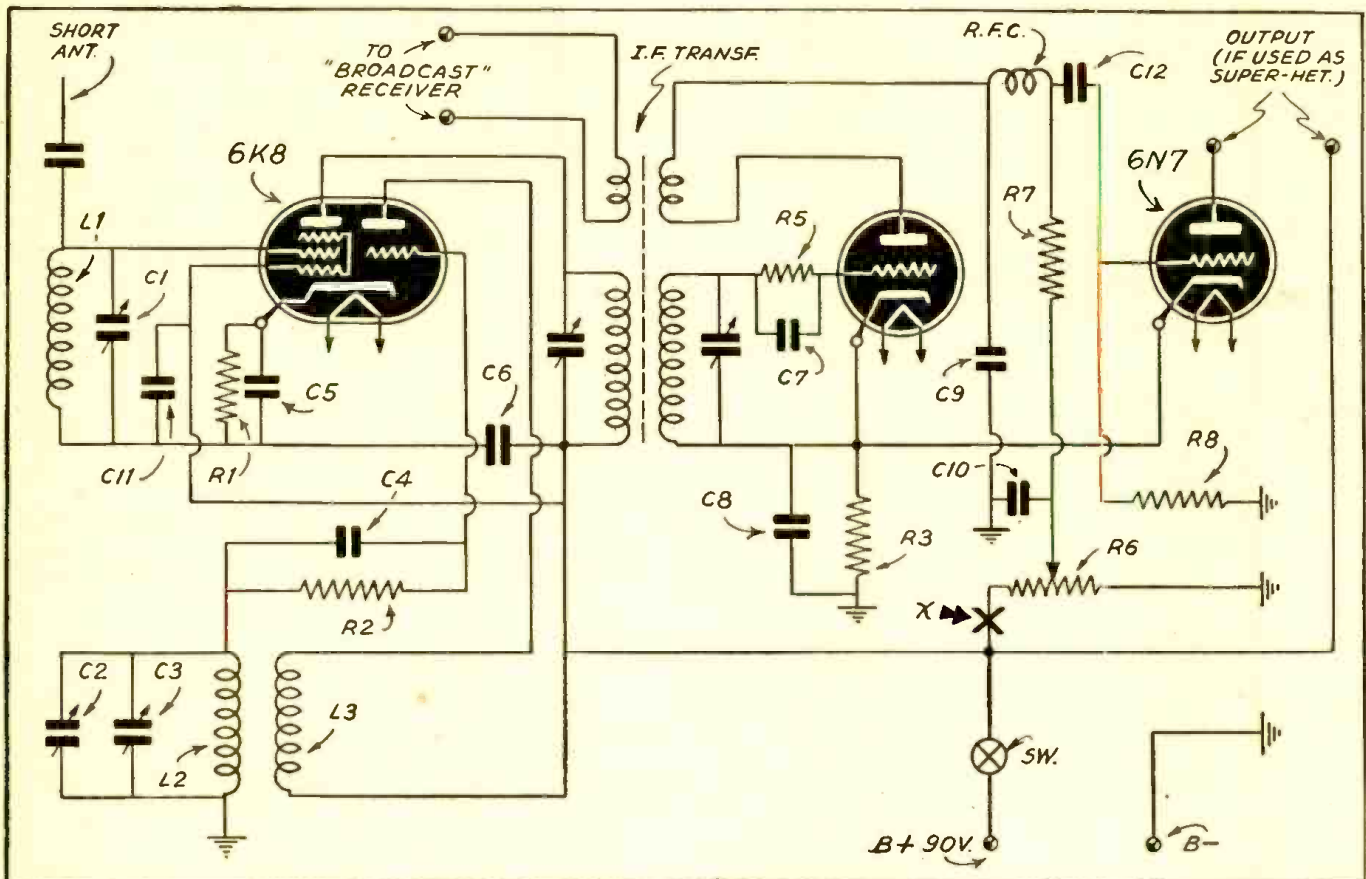

Wiring diagram of the "receiver-converter." The respective output terminals for connection to a regular broadcast receiver are shown, as well as the output terminals if the set is to be used as a "superhet" by itself.

to give any definite data on coil sizes. In this particular case the first detector tuning coil was wound with eight turns of #24 enamel wire on a 1/2" x 3/4" pillar insulator. The oscillator coil was made up of about 5 turns of #12 wire wound on a 3/4" x 1 1/2" pillar insulator and spaced the diameter of the wire. The plate coil is wound between these turns and is made of #20 solid push back wire. Winding the coils on this type of insulator gives a good low loss coil form which holds the coil rigid even under severe vibration. Windings of small wire are anchored to soldering lugs bolted to each end of the form and the large wire is wound slightly smaller than the form and sprung while it is slid over the insulator.

Aligning I.F. Section: To align the I.F. section, connect the headsets and turn the regeneration up until the second detector just oscillates. Then tune the plate circuit of the mixer tube until it comes to resonance. This is indicated by a sudden "pop" in the phones and the ceasing of oscillation. When regeneration is turned up farther, oscillation should start again. The I.F. does not have to be tuned to exactly 1500 kc. but to any nearby frequency which clears strong local stations.

Used as Converter

When used as a converter the two link terminals are coupled to the antenna input of your "broadcast" receiver. The broadcast receiver is then tuned to 1500 kc. A quick way to tune the receiver on the nose is to turn the converter's regeneration control full on. The detector section of 6N7 will oscillate on 1500 kc., giving a signal to

which the receiver is tuned. The regeneration is then backed down and the set is ready to go. For normal converter use this control is left at minimum. For greater selectivity the regeneration is pushed almost to the point of oscillation. If the broadcast receiver has no beat oscillator, CW signals can be received by pushing the regeneration just past the oscillation point.

As a Receiver

To use as a receiver the broadcast set is left disconnected and the phones are plugged in. For very strong local signals the re-

generation is left near zero. To increase selectivity and sensitivity this control is advanced and for greatest gain and almost single signal selectivity, the regeneration is pushed up to just below the point of oscillation. For CW reception the second detector is forced into the point of oscillation.

Although built as an experiment, the results are more than satisfactory. Even though it was not made to compete with larger receivers, it will put up a good scrap with some many times more elaborate than itself. With only a four foot antenna it gave good account of itself on some real dx. For those who do not care for it in such a compact form, this circuit should give even better results when spread out on a larger chassis.

NOTICE

RADIO & TELEVISION
Subscribers:

Inasmuch as RADIO & TELEVISION magazine has been merged with RADIO-CRAFT, all RADIO & TELEVISION subscribers will receive copies of the merged magazine to the conclusion of their subscriptions.

Where readers are subscribers to both magazines, the subscription will be lengthened in the same manner. As there was no October RADIO & TELEVISION, all subscriptions will be extended two months.

THE PUBLISHERS.

Parts List

- C1 100 mmf. variable condenser
- C2 15 mmf. variable condenser
- C3 50 mmf. variable condenser
- C4 100 mmf. mica
- C5 .01 mf. paper condenser
- C6 .1 mf. paper condenser
- C7 250 mmf. mica
- C8 .01 mf. paper
- C9 500 mmf. mica
- C10 .25 mf. paper
- C11 .01 mf. paper (omit when screen is connected to plate supply for 90 volt operation, C6 is sufficient)
- C12 .01 mf. paper
- R1 300 ohms 1/4 watt
- R2 50,000 ohms 1/4 watt
- R3 500 ohms 1/4 watt
- R4 50,000 ohms 1 watt (to be inserted at "X" if more than 90 volt plate supply is used)
- R5 2 or 3 megohm 1/4 watt
- R6 50,000 ohms variable resistance with switch "SW"
- R7 100,000 ohms 1/4 watt
- R8 500,000 ohms 1/4 watt
- T 1500 kc. iron core I.F. transformer
- L1, L2, L3. See text
- 2 octal sockets, 2 phone jacks, 2 bar knobs, dial
- 4 terminal strips, 1/2 x 3/4 pillar insulator, 3/4 x 1 pillar insulator

Now READY!



EVERY Radio Mechanic—Service Man & Student Needs "Auodels Radiomans Guide!"—Just Out!

The whole subject of Modern Radio—covering the Basic Principles—Construction & Operation—Service—Repairs—Troubles—All Easily Understood. Over 750 Pages, 400 Illustrations, Parts & Diagrams—LATE TELEVISION DATA—Valuable for REFERENCE AND HOME STUDY.

4 To get this practical information in handy form for yourself fill in and mail coupon today.

COMPLETE • PAY ONLY \$1 A MO.

AUDELS Publishers, 49 W. 23rd St., N. Y. Mail AUDELS NEW RADIOMANS GUIDE for free examination. If O. K. I will send you 1 in 7 days; then remit \$1 monthly until price of \$4 is paid. Otherwise, I will return it.

Name _____
 Address _____
 Occupation _____
 Reference _____

**ANNOUNCING
 A NEW MASTER
 TELEPLEX
 To Teach You the Code**

The Master Teleplex Code Teacher has been streamlined to make it easier for you to learn the code. Yes, the same engineers who developed the original TELEPLEX have worked out an entirely new principle. This new machine records your sending visibly by a brand new method on a specially prepared tape and also sends back your own key work at any speed you wish. Thus you learn by hearing as well as seeing. There are **NO PERFORATIONS—NO INK**. Far superior to anything ever developed. . . . A marvel of simplicity. Teleplex machines are used by practically every school teaching the code. Regardless of whether you wish to learn code as a hobby, a vocation, or to teach, you will surely want to see this new Master Teleplex.



We furnish you a complete course, including practice messages, the new Master Teleplex plus a personal service on a money back guarantee. Low Cost. Easy terms. Special trial offer to any responsible defense unit. Write for complete information.

TELEPLEX COMPANY 107 Hudson St. Dept. S10 Jersey City, N. J.

RADIO ENGINEERING,

broadcasting, aviation and police radio, servicing, marine radio telegraphy and telephony, Morse telegraphy and railway accounting taught thoroughly, 48 weeks' Engineering course equivalent to 3 years of college radio work. All expenses low. Catalog free. School established 1874. The Dodge Institute, Turner St., Valparaiso, Ind.

ANTENNA FOR CRAMPED SPACE

● THE part of the equipment that supports the doublet is a fishing pole with the ends bent up. The lead-in wire is attached to (A) brass bolts, which bear on the copper rings (B). The lead-in wire is then taken off the rings and into the shack through the chimney. Commutator equipment can be installed for added rotation at end of pole (C) if desired.—Clyde Moss, Jr.

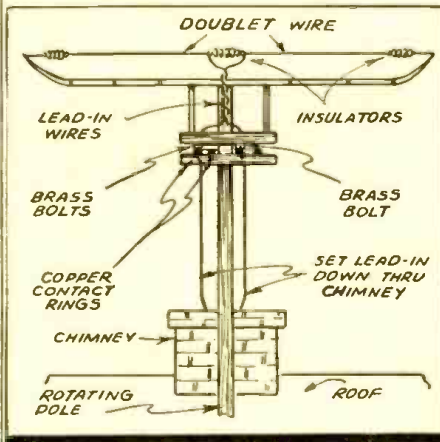

STANDARDIZE YOUR TRANSMITTER LINK COUPLING

● IN amateur transmitter construction the link coupling used from stage to stage is usually a haphazard affair with no flexibility when it comes to changing coils for radical change of frequency. The writer recently installed a link coupling cascade after that shown in the sketch and now coils can be rapidly changed without disturbing the linking in the least.

The system consists of a permanent link coil being soldered to each tank or grid coil socket as the case may dictate. An average of two turns of insulated hard drawn copper wire (No. 18) was fashioned as indicated with the terminals soldered to two spare terminals on the socket. The link coil was slightly larger than the coil and centered so the latter would slip in easily. It has been shown by experiment that a link of small diameter silk covered twisted gives as large a transfer of energy as anything the writer has ever used. Therefore if, between sockets, a link line of No. 24 to No. 28 silk covered wire is used the feeding of energy from stage to stage will approach maximum.—L. B. Robbins

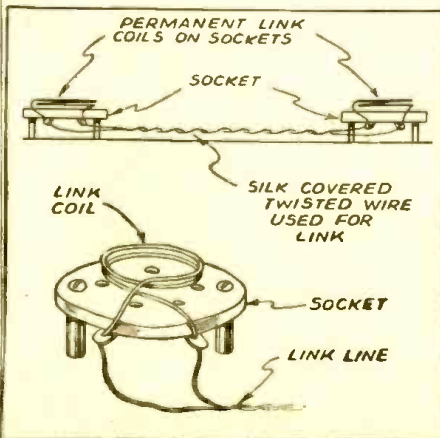

ASSURED STABILITY

WITH **BLILEY CRYSTAL UNITS**

0-20-40-80-160 METER BANDS



TYPE B5—This highly active crystal unit for the 40 meter band has less than 4 cycles/mo/°C drift. Price \$4.80.

TYPE LD2—An efficient and powerful low drift crystal unit for the 80 or 160 meter band. Price \$4.80.

TYPE HF2—Simplifies the construction of 5-, 10- and 20-meter transmitters. Drift, 20 meters, 20 C/mc/°C. Price, 20 meters, \$5.75.

TYPE BC3—A moderately priced mounted crystal with unusual activity and power output. Drift 23 C/mc/°C. Price, 40, 80 or 160 meters, \$3.35.

BLILEY ELECTRIC CO. • ERIE, PA.

CODE

YOU CAN LEARN IT QUICKLY AND EASILY

Our way is fun while learning



Why not learn to be an operator quickly and easily with the

Ayers Automatic Code Machine all electric, 50,000 words practice tapes available, low monthly rental.

TAPES FOR MAC AUTOS, RECORDING SLIPS AND RECORDING INKS

Write **AYERS AUTOMATIC CODE MACHINES** 711 Boylston St., Boston, Mass.

SHORT WAVE CONVERTERS for CAR RADIOS



Can be attached to any car radio.

MODEL 600-A covers 49-31-25-20-19 and 15 meter bands. Designed for American and Foreign short wave broadcast. Distance range 5,000 to 10,000 miles. List Price \$24.95

MODEL 700 long wave covers 135 to 410 kc. Receives gov. weather reports, etc. List Price . . . \$24.95

POLICE UNITS MODEL 100-A with fixed condensers, covers 1600 to 2600 kilocycles. \$12.50

MODEL 800 Super Sensitive police converter with fixed condenser. Covers 1500 to 2600 kc. Two metal tubes, exceptional distance range. List Price . . . \$15.95

MODEL 200 with variable condenser, covers 1550 to 8000 kilocycles. List Price \$17.95

MODEL 300-A with variable condenser and illuminated dial covers 1600 to 6000 kc. Very sensitive, has two metal tubes. Exceptional distance range. List Price \$21.95

3334 N. New Jersey St., Dept. RT-12, Indianapolis, Ind., U.S.A.

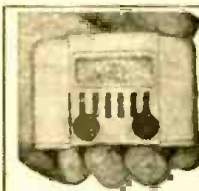

NEW! 1941 MODEL! MIDGET RADIO!

NO TUBES NO BATTERIES NO PLUG-IN DURABLE PLASTIC CABINETS DUAL BANDS—MAGICTENNA—MICRODIAL Plus your pocket or purse—Wt. 6 ozs. Small as cigarette package. Receives standard & some shortwave. PATENTED POWER RECTIFIER. No tubes, batteries, Hi-milo easy tuning slide "MICRODIAL."

M. L. OF ILL. SAYS: "MIDGET RADIO WORKS FINE!" ONE YEAR SERVICE GUARANTEE! Sent complete ready to listen with instructions & tiny phone for use in homes, offices, hotels, in bed, etc. SIMPLE TO OPERATE—NO ELECTRICITY NEEDED! SEND NO MONEY! Pay postman only \$2.99 plus postage charges on arrival or send \$2.99 (Check, M.O., Cash) and yours will be sent postpaid. A MOST UNUSUAL VALUE! ORDER NOW! FREE PLUG IN "MAGICTENNA"—ELIMINATES OUTSIDE WIRES! MIDGET RADIO CO., Dept. RT-12, Kearney, Nebr.

COLOR CODED LEADS

When I buy appliance wire, I save the small yellow metal tag that is found on the wire every few feet. Then I paint two of them the same color; two red, two green, etc. Before making cables, I place one of these at each end of the wire, thus insuring identification of each wire in a power cable, inter-communication system, etc.—G. Chandler Robinson.

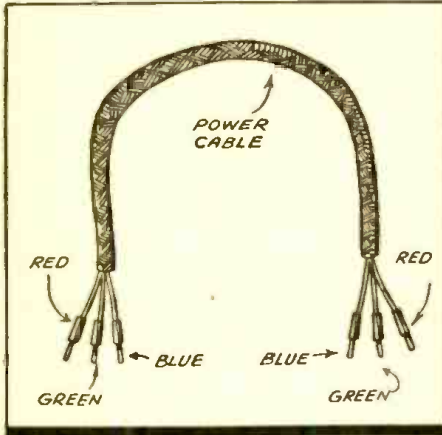

D.C. POWER-SUPPLY

● FOR some time the writer operated a low power transmitter using a power supply composed entirely of two five-to-one ratio audio transformers. Later it was tried out as a receiver power-supply and worked nicely. It used a Raytheon rectifying tube (no filament) but could be easily adapted for use with a modern rectifier by utilizing a suitable filament transformer. While the five-to-one transformers provided nearly 400 volts of rectified current, two three-to-one transformers will give about 250 volts output at higher current rating.

The trick in this hook-up is that the primaries of the two transformers are connected to the 110 A.C. line, in parallel with a limiting resistor in the form of a 25 to 40 watt lamp in one line. Then the secondaries are connected in series and center-tapped between them.

With a 40 watt input (110 volts at approximately 400 mils) the output will be approximately 400 volts (using 5-to-1 transformers) at about 60 mils; sufficient for operating a transmitter of less than that consumption—or a 6-tube receiver.

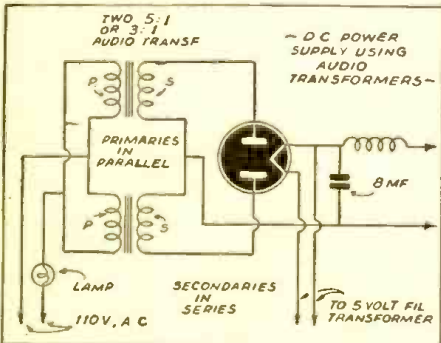

BOOK REVIEW

NEW GHIRARDI SERVICING BOOK—The new Ghirardi Handbook is a large volume of 710 pages, 8 1/2 x 11 inches (manual size), bound in gold-lettered Fabrikoid with stiff covers. Published by Radio & Technical Publishing Co., New York City. Price \$3.50.

Now featured among the 710 manual-sized pages of useful data are 386 pages of trouble

SEND NOW FOR THIS HANDY, NEW,

OHMITE Ohm's Law Calculator

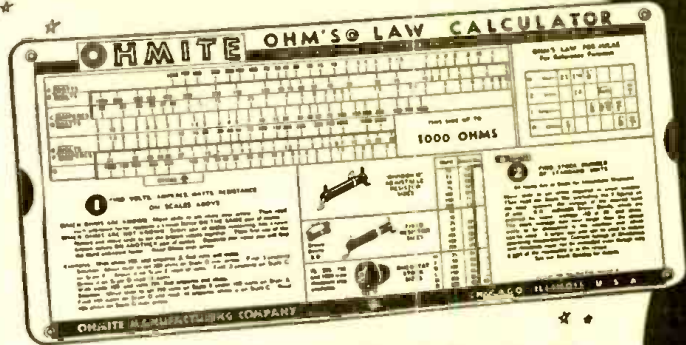

Solves any Ohm's Law Problem with one setting of the slide.

Everyone can use this remarkable Calculator! All values are direct reading. No slide rule knowledge is necessary. Figures Amperes, Volts, Watts, Ohms—quickly, accurately. Scales on both sides cover the currents, resistances, wattages and voltages commonly used in radio, sound and electronic applications. Specially designed for you by Ohmite Engineers. Size 4 1/8" x 9". Get your Calculator now!

At Your Jobber or Send the Coupon Today!

ONLY **10¢** to cover handling cost

OHMITE MANUFACTURING CO.
4896 Flournoy St., Chicago, U. S. A.
10c in coin enclosed. Send Ohm's Law Calculator. (Please Print Clearly)

Name
Address
City State
R.C.—Dec. '41

Be Right with **OHMITE**
RHEOSTATS · RESISTORS · TAP SWITCHES

Here Is Everything You Need to Know to Be a Radio Amateur . . .

156 PAGES! OVER 100 PICTURES!
EASY TO READ! ☆☆☆

☆☆☆ Takes you step-by-step through everything you need to know to be an amateur and have your own radio station. Written so anyone can easily follow the instructions, this textbook is a great help to the beginner or the full-fledged amateur.

☆☆☆ You can learn how to build your first transmitter and receiver—how to learn code—how to get your license—how to use your beginning equipment in building larger and more advanced rigs. Here is radio theory really made understandable.

Bound in cloth and stamped in gold. Obtain a copy from your Radio Parts Distributor, or write direct to THORDARSON.

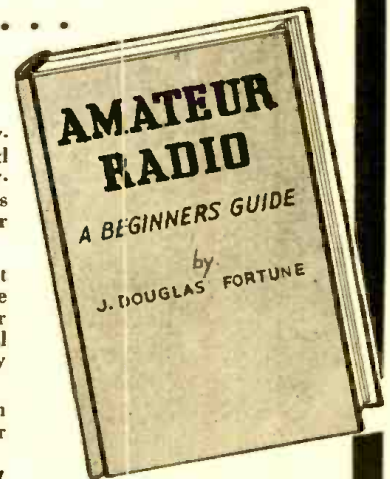

THORDARSON
ELECTRIC MFG. CO.

ONLY **75c** POSTPAID
500 West Huron Street, Chicago

"Transformer Specialists Since 1895"

"Case Histories" for over 4,600 models of receivers and automatic record-changers (the largest "Case History" compilation ever published), a 50-page tabulation of the receiver "I-F Peaks" and alignment data for practically every known superhet receiver, 60-pages of tabulated data and charts compiled particularly for the auto-radio specialist, replacement and comparable battery specifications and data charts for 1,250 portable radio receiver models. Of special value is the most complete tube chart ever published—20

pages long—giving for the first time anywhere, complete information on the characteristics, classification, interchangeability and socket connections of every type of American receiving tube.

Included also among the remaining 180 pages are comprehensive trade directories of all manufacturers related in any way to the radio industry, and 53 more reference charts and graphs presenting permanently useful data on a variety of important subjects such as ballast resistors, dial lamps, tube testing, magnet wire.

3-Tube DX-er with A Wallop!

L. M. Dezettel, W9SFW*

European short-wave stations are picked up easily on this 3-tube highly efficient receiver. Plug-in coils permit tuning in the various short-wave bands to be tuned in. An ideal battery-operated set for the beginner.

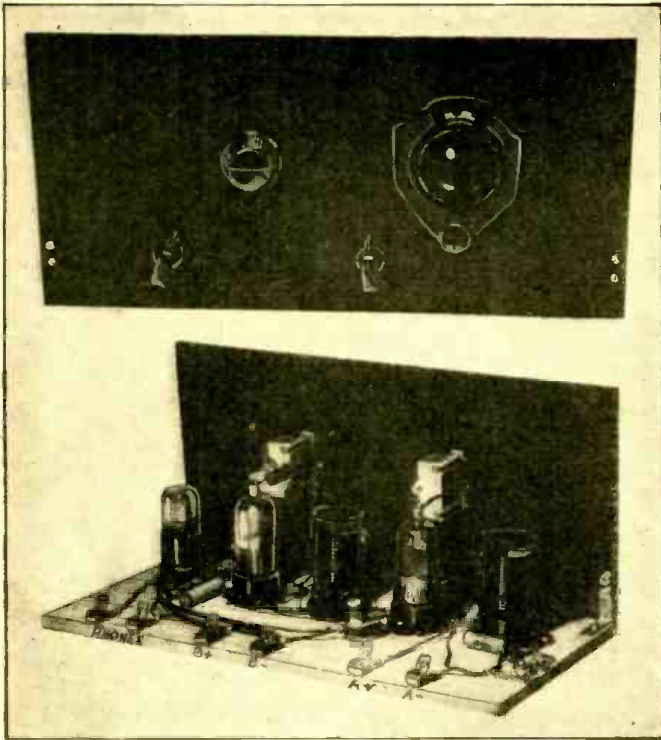

Photos at left show front and rear views of the 3-tube DX-er. Plug-in coils permit tuning in the various short-wave bands.

or an inexpensive magnetic speaker may be connected.

Before any work is begun on this set, you should make sure that you have all of the parts, as well as a suitable base and front panel. The baseboard is made of plywood and measures 7 inches by 14 inches. The panel in the model shown in the photograph was made of black crackle finish masonite, measuring 7 inches by 14 inches. Angle brackets are used to support the front panel to the baseboard.

Laying Out the Parts

The layout of parts is quite important but can be estimated from the photograph of the back view. Drill the front panel and mount the two variable condensers and two potentiometers on it first. Fasten the eight Fahnestock clips to the baseboard, approximately as shown in the photo. Fasten the

● FOR the beginner and experimenter who wants a receiver just a little bit better than the one or two tube battery set, we are presenting details on construction of a three tube "DX-er". The title is rightfully applied, because this little set really steps out and picks up the DX stations, including the major short-wave stations of South America and Europe.

As you will notice by the circuit, there is an R.F. stage, a regenerative detector stage, and a power amplifier stage, capable of operating a loud speaker on the more powerful stations. Battery requirements are very simple. Flashlight cells may be used for the "A" batteries, but a No. 6 dry cell will give much longer life. Two standard 45 volt "B" batteries, connected in series, supply the plate voltage. Automatic biasing is used in this circuit, so that no "C" battery is necessary.

Let us take a look at the circuit diagram and see how really simple this set is. A 1N5GT tube is used as R.F. amplifier. The antenna coil is a standard 4 prong, two winding plug-in coil. These coils are available in sets of four to cover the entire short-wave band from 9.5 to 217 meters. A set of two coils is used to cover the broadcast band. Notice that the ground return (terminal 1) on the secondary of the coil connects through a 100,000 ohm resistor to the center arm of a 50,000 ohm potentiometer. Varying the potentiometer varies the bias and therefore the amplification of the 1N5GT tube. The output of the R.F. tube is connected to an 8 mh. choke, which is capacity-coupled to the regenerative detector stage. The detector tube is the triode portion of a 1H5GT. The 1H5GT tube has a diode element in it, but we do not use this in this circuit. The high mu triode portion of this tube makes an excellent regenerative detector. The detector coil is a four prong plug-in type, the same as is used in the R.F. stage. Proper connection to the coil socket

is important, and the numbering as shown in the circuit should be followed. A 140 mmf. variable condenser in each stage tunes the R.F. and detector coils. A vernier dial is used on the detector stage tuning condenser, as tuning in this stage is quite critical and must be done slowly. A small knob on the R.F. stage tuning condenser is sufficient there. Regeneration in a detector stage is controlled by a 50,000 ohm potentiometer which acts as a variable shunt on the tickler winding of the coil. The detector stage is capacity coupled to a 1C5GT power amplifier tube to which a pair of earphones

Below is a wiring diagram of the 3-tube DX-er.

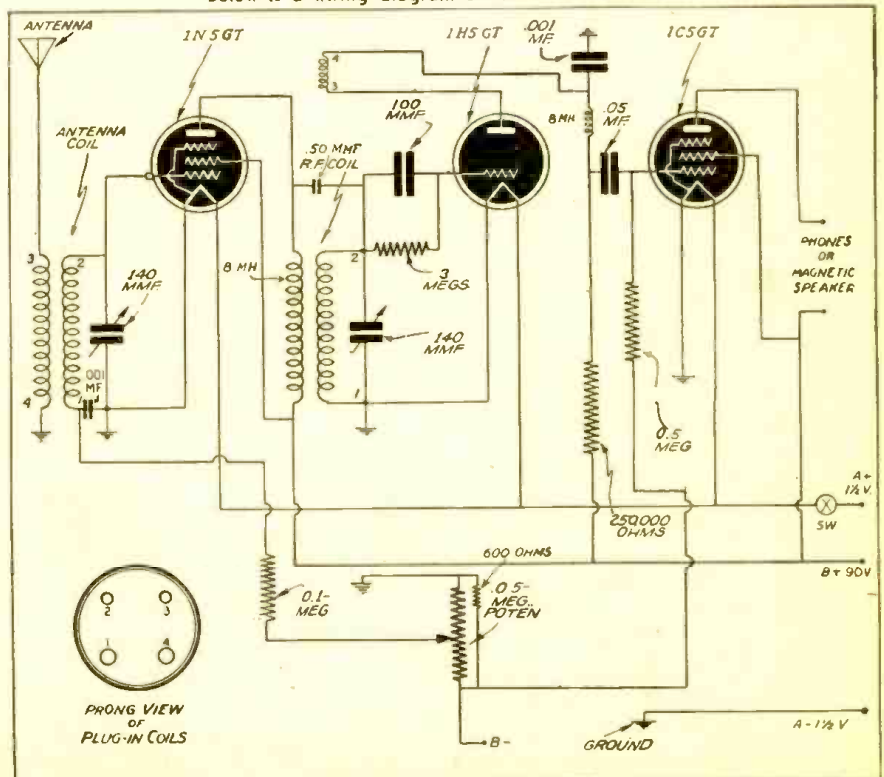

*Engineer, Allied Radio Corporation.

five sockets to the baseboard, locating them in a row as shown. Four prong base mounting sockets are used for the coils and octal base mounting sockets are used for the tubes. When mounting the sockets, be sure to keep in mind that you should have the shortest possible leads to each of the socket terminals. The following arrangement will help:

The R.F. coil socket on the right (back-view photo) should be faced so that the large pin holes are towards you as you view it from the back. To the left of the coil socket is the 1N5GT tube socket. The guide pin slot should point in the direction of the panel. The socket in the center is for the regenerative detector coil, the large pin holes on this socket should be towards your left. The detector tube socket should have its guide pin pointing towards the back and the power amplifier socket (the last one on the left) should have its guide pin slot facing the panel. 1/4" No. 6 wood screws are used to fasten the Fahnestock clips and 5/8" No. 4 wood screws are used for the sockets. The fixed tubular condensers, resistors, and R.F. chokes are supported by their own wire leads.

A careful job of soldering is necessary if continued good results are to be expected from this, or any other set. Acid core solder or acid liquid should never be used when soldering electrical connections. Rosin core solder will not corrode the connections, and it is just as easy to use if the soldering iron is applied to the connection, and only a small amount of solder is allowed to flow into the connection. Connections to the Fahnestock clips may be made by means of soldering lugs or the ends of the wire may be fastened under the wood screws. The 3 megohm resistor and .0001 mfd. mica condenser are connected to the 1H5GT tube right at the grid cap. Make all connections as short and direct as possible. Short connections are important at the very short wave lengths.

Testing the Set

Let's connect an antenna and ground to the receiver. The antenna should be a single wire, 75 to 100 feet long and well insulated. The ground can be a good connection to a cold water pipe or to a 6 foot metal rod driven into moist earth. Connect an "A" and "B" battery, and earphones to the six terminals on the back. If you have used a volume control with a built-on switch, as recommended, rotating the volume control knob will turn the set on. Set the volume control at its maximum point (all the way to the right). Turn the regeneration control until a dull thud is heard (which is where oscillation begins) and let it set, temporarily, at this point. Rotate the detector tuning condenser slowly, and at the same time turn the R.F. tuning condenser back and forth, until a station is heard. Use broadcast band coils for the first trial. You should hear several squeals as the detector tuning condenser passes over the stations. When you have one of them tuned in, reduce the regeneration control until the squeal stops. As you reduce the regeneration control, a slight re-setting of the detector tuning condenser is required. A point will be found where the stations come in with maximum volume. If it is too loud, and sounds distorted, reduce the volume control.

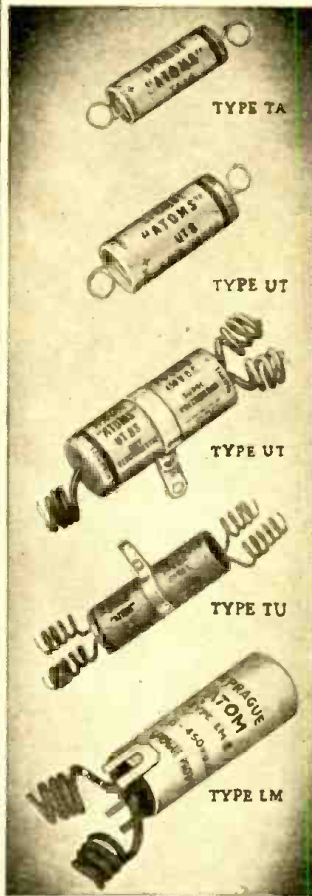

5 SPRAGUE ATOM TYPES

FOR BETTER, SMALLER, MORE ECONOMICAL REPLACEMENTS

Of course you know Sprague ATOMS—the "blow-up proof" midget dry electrolytic condensers that have literally made larger, old-style condensers obsolete. But did you know there are five different ATOMS types—types that make these popular midgets practically universal for any replacement job whether it be single-section, multi-capacity, lug-mounting, or calls for separate positive and negative leads? Did you know leading manufacturers specify ATOMS for equipment to be shipped overseas—because ATOMS are so uniformly dependable under bad atmospheric conditions? And did you know that ATOMS are so rugged, they'll even stand up in many jobs where old style large dry and wet electrolytics were formerly specified?

Play safe. Use Sprague Atoms in EVERY job.

YOU SAVE THREE WAYS:

Make up hard-to-get replacements by strapping individual Atoms together with ST Mounting Straps — supplied free! You'll find the combined Atoms actually smaller, often cheaper, and fully as reliable. You save time—money—space.

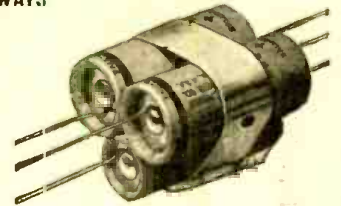

SPRAGUE CONDENSERS

Sprague Products Company
North Adams, Mass.

New SELF-BALANCING
DRIFT-CORRECTING
DIRECT-COUPLED AMPLIFIERS
FOR DISCRIMINATING MUSIC LOVERS
Designed by A. C. Shoney

These new amplifiers bridge the gap between the laboratory and the home, and make available for the first time, extraordinary equipment at less than ordinary prices. Built in a new way, without interstage coupling condensers or transformers. Although specifically designed to meet the strictest requirements of professional sound engineers, these direct-coupled amplifiers embody all desirable features sought by the most discriminating music lovers. Send for Literature.

AMPLIFIER CO. of AMERICA
17 W. 20TH STREET, NEW YORK, N. Y.

The Greatest Book Value Ever Offered to Radio "Fans"—
RADIO AMATEUR COURSE
See Page 319

Inventions Wanted
Patented or Unpatented

We have been successfully selling inventions, patented and unpatented, since 1924. Write us, if you have a practical, useful idea for sale.

CHARTERED INSTITUTE OF AMERICAN INVENTORS
Dept. 109 Barrister Building, Washington, D.C.

Do you need BINDING POSTS?

The XL PUSH POST with its Spring Action assures Constant Contact and Quick Connection.

Manufactured in All Aluminum Type M at 12c each. Bakelite Top Type B1 at 15c each.

Types CP or NP. ALL BRASS—STAINLESS STEEL SPRING & PIN. PROVEN BY 240 LB. SALT SPRAY TEST as NON-CORROSIVE at 28c each.

Manufacturers and Dealers Liberal Discounts

X. L. RADIO LABORATORIES
420 West Chicago Ave., Chicago, Ill.

A Mercury Vapor Sun Lamp



Appearance of the Mercury Vapor Sun Lamp, as built by the author.

● THE construction of a vapor sun lamp is a comparatively simple task, provided the builder understands the basic theory. It is the purpose of this paper to present the theory, and then give the details for making a mercury vapor sun lamp, using one of the least expensive bulbs on the market.

Basically, the light from a mercury vapor lamp is due to the vaporization of the mercury in the bulb. Some means must be pro-

vided in the bulb for heating the mercury so that it vaporizes. The methods used by the various manufacturers are, of course, not all alike. Perhaps the simplest way of vaporizing the mercury is with the use of a filament in the bulb which is heated to incandescence. The heat given off by the filament is sufficient to vaporize the mercury, which forms an arc between the electrodes of the bulb. The voltage drop between electrodes is approximately 15 volts, and it is for this reason that the lamp cannot be used directly across a 115 volt line.

The bulb used by the writer is a Sperti Mercolite, number 40TC, and may be purchased at any large electrical or department store for about \$6.00. It draws a current of 5 amperes, and since the voltage drop through it is about 15 volts, it is necessary to use a limiting resistor in series with it, if it is desired to use the 115 volt A.C. supply. The voltage drop across the resistor must be 100 volts (115-15), and since the current is 5 amperes, the power consumed in the resistor is 100×5 or 500 watts. It was found that a resistor, such as is used in a radiant heater, rated 115 volts at 660 watts, served the purpose, and could be purchased for \$0.25.

The physical construction of the lamp can be made to suit the builder's requirements. An intermediate base type socket is required for holding the bulb, and a standard base for holding the limiting resistor. A small reading lamp was purchased by the writer

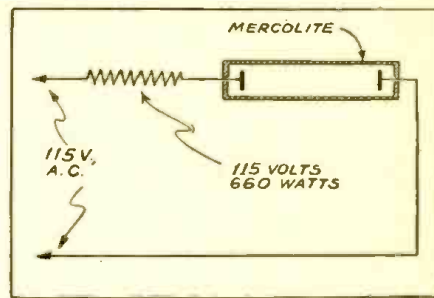

Wiring diagram of the Sun Lamp.

which proved very handy for mounting the bulb and resistor. This was accomplished by removing the standard base socket in the head of the lamp and placing the intermediate base there instead. The shade of the lamp is long enough to accommodate the mercury bulb. At the base of the lamp the socket for the resistor was mounted by drilling through the base and attaching the socket with screws. The resistor should be mounted so that it does not come in contact with any wires or other equipment, as it becomes very hot when the bulb is being used. The actual construction can be seen in the photograph.

Herewith is the wiring diagram.—V. Petrucelly, Jr.

"Sun glasses should be used for the eyes for protection when the sun lamp is used. These may be obtained at the place that supplies the Mercolite bulb."

How to Use Mercury Switches

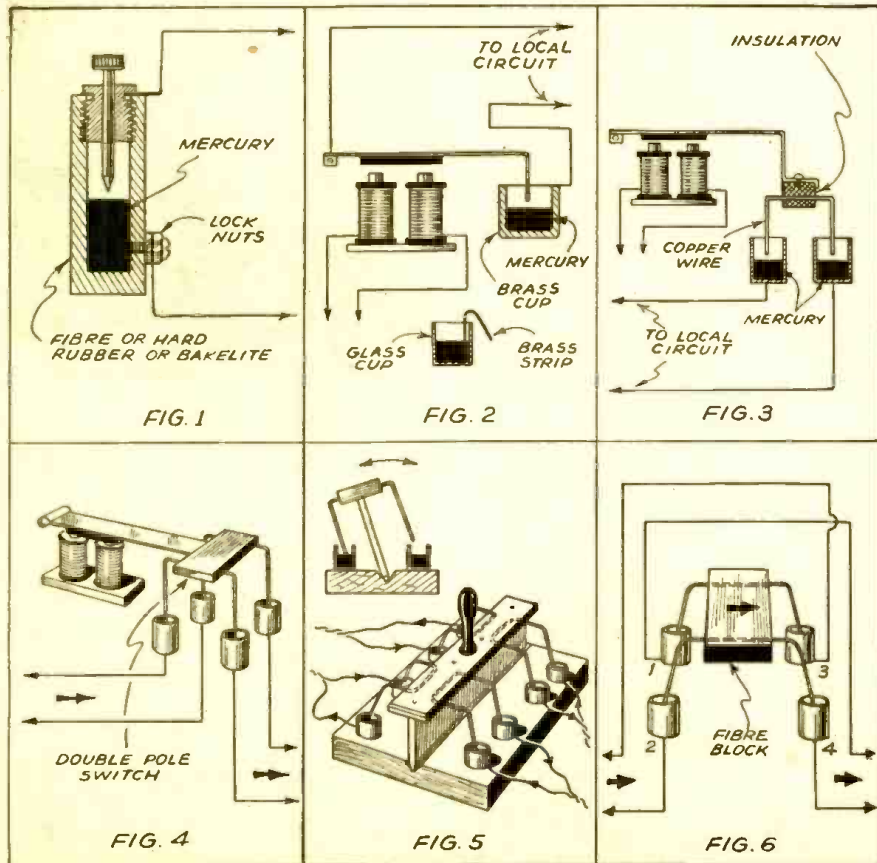

● MERCURY cup switches are not so widely used today in the laboratory or for time clocks and other devices as they once were, but many times the experimenter will find them extremely handy and a few hints on their construction are given herewith. Fig. 1 shows how a simple fire alarm mercury switch can be made from a fiber or other insulating tube. An adjustable contact screw is mounted in a brass or other threaded piece at the top of the tube, so that the lower end of the screw can be raised so as to just fail to make contact with the mercury. When the room temperature rises, the mercury will expand and cause it to rise so as to make contact with the upper screw, thus closing the circuit and sounding an alarm. The column of mercury need only be about 1/16 to 1/8 of an inch in diameter and an inch or two in length. Figs. 2, 3 and 4 show how to rig up an old electric bell (telegraph sounder or similar magnet system) so as to act as a circuit-breaker. Mercury cups made of brass or possibly glass are arranged as shown, and at Fig. 2 a single-contact break is made. At Fig. 3 a "U" shaped wire member supported in a piece of insulation (fiber,

The average electrical experimenter may not have used mercury switches very much, if at all, but they frequently serve a very useful purpose. As the diagram shows, mercury cup contacts prove most useful for circuit interrupters and emergency or special switches.

PRACTICAL CHRISTMAS GIFTS FOR THE WHOLE FAMILY

Unusually attractive 16 page Holiday books beautifully illustrated and lithographed with complete text covering each subject.

- The Story of Jesus Old Testament Stories Bible Stories New Testament Stories
- Size 8 3/4 x 4 1/2 4 for 40c
- A Christmas Day with Longfellow
- A Christmas Day with Tennyson
- A Christmas Day with Whittier
- Size 8 1/2 x 3 1/2 3 for 30c
- The Secret of a Happy Day
- Hark the Herald Angels Sing
- He Leadeth Me
- I Need Thee Every Hour
- Nearer My God to Thee
- The Lord Is My Shepherd
- Size 6 3/4 x 4 1/4 6 for 50c

All 13 books parcel post prepaid \$1.00
 Christmas Candle Lights by Noma. Fitted with G.E. Mazda Lamps. Candles in different colors. 8 Candle Lights completely wired, packed in an attractive Christmas box, ready to use, parcel post prepaid. \$1.00

Crystalite Reflectors (P), an unusually attractive Christmas Tree ornament fitted with G. E. T-4 Mazda lamps. Each Crystalite is made up of a center dome-shaped cut glass in different colors to which 9 cut glass petals in contrasting colors are clamped. Packed 8 in a carton. 1 Box \$1.00

Shakespeare miniature set of 10 books (P), un-abridged, page size 3 1/4" x 2 1/2", in clear readable type, flexible cover of genuine leather in different colors, titles embossed in silver. 2.00

Same as above in dull finished walnut rack. 2.50
 (A most suitable Christmas, Birthday, or Graduation Gift.)

U. S. Spotlight for photography (6) with 9" nickel silver reflector. Fitted with powerful Westinghouse S 11 bulb, 6 ft. rubber cord, fits into any AC-DC house socket and on any tripod with standard head screw. 3.85

Same lamp as described above (6) with G. E. No. 1 (750 c.p.) flashlight bulb. Black crackle finish 3.60

U. S. Signal Corps Tripod (6), for surveyors, one piece, made of hardwood with bronze head and fittings. 1.95

U. S. Adjustable tripod (6), made of selected straight grained hardwood, fitted with sturdy clamps. Adjustable from 44-88", with standard head screw to fit any camera. 3.00

(When ordered with any of the above described lamps). 2.00

Tuch-Rite (P) typewriter touch system teacher (recommended by the U. S. office of Education, Washington, D. C.) 2.00

Imperial Health Brace (P), with 2 sewed in flexible steel reinforcements. For men and women, any size 2.00

for boys and girls, any size. 1.50
 (When ordering, please specify for men or women, and give chest measurement under arms.)

Jiffy Therapeutic Face Massager (P), with rubber cord to plug into any AC-DC house socket. 1.00

Sun-Mite Sr. (P) Ultra-Violet health lamp. Table model, 2 carbons, goggles, and six foot cord to plug into any AC-DC house socket. 2.95

Sun-Mite Jr. (P) same as above with screw base. 2.45

Sturdy Jiffy magazine binders (P) —

(a) 12 3/8" x 9 1/2" with 2" back fits RADIO NEWS, RADIO-CRAFT, etc. 2.00

(b) 10 1/2" x 7 1/2" with 3" back fits POPULAR MECHANICS, etc. 1.75

(c) 8 1/2" x 6 1/4" with 3" back fits READER'S DIGEST, etc. 1.50

Sky Pilot World Time Clock (P) instantly indicates time in all 24 zones throughout the world. Invaluable for Radio Amateurs and Short Wave Listeners. 5.97

Add-O-Matic adding machine (6) all metal, 5 columns, with complete instruction book, (\$11.95 value) your cost. 6.95

Arithmometer adding machine (P), in leather case, all metal, fits vest pocket—suitable for office, store, and home. Adds, subtracts, and multiplies. 2.50

8" slide rule with flat magnifier (P) in pocket case. .25

Same as above with 36 page instruction book. .35

10" slide rule with powerful round magnifier (P) white enameled, in fine black leatherette case.50

Same as above with 36 page instruction book.60

36 Page instruction book only (P)15

Lawrence Secret Code Slide Rules (P) complete with instruction books. 1 set—35c, 2 sets50

G. E. high speed motor (3) Brand new, 5,000 R.P.M., 1/50 h. p. 4.95

NOTE: Where the letter (P) appears after the name of an item, it means Parcel Post Prepaid BY US. When a number () appears after any item, include in your remittance, the proper express charges for the number of pounds your purchase represents. When such amounts are not included in your remittance, we will ship express charges collect.

GOLD SHIELD PRODUCTS

(Dept. RC1141)

350 Greenwich St., New York City

(Write to us on any reconditioned fractional h.p. motors you need.)

RADIO-CRAFT for NOV.-DEC., 1941

etc.) dips into the mercury cups and opens or closes the circuits. At Fig. 4 a double pole switch is shown and here the block of fiber (or other insulation) mounted on the armature of the bell makes or breaks contact by means of two U-shaped wires dipping into mercury cups. The arcing at the surface of the mercury may be partly obliterated by placing a little oil on top of the mercury.

Fig. 5 shows a laboratory type of mercury switch which often comes in handy; these switches have been made with as many as a dozen contacts and more. The central member is made of fibre or other insulating material and the lower edge of the upright may either be wedge-shaped and the switch simply allowed to rock back and forth in a "V" shaped slot cut in the base, or it may be arranged with pivots on either end. This switch rests at an angle on either one side or the other of the base, as the diagram indicates, and the U-shaped copper or other wires make contact in the mercury cups. Various arrangements of the switch conductors may be worked out by the ingenious experimenter, so that a great number of time-saving and intricate connections may be made by one throw of the switch, the switch being actuated either manually or by a set of magnets from a bell or telegraph sounder.

Fig. 6 shows a simple four-way pole-changing switch for manual operation. The fiber block containing the two U-shaped wire members may be placed in the mercury cups so as to connect 1 and 3, also 2 and 4; if the switch is turned 90 degrees and then placed in the cups, which are laid out on a square as shown, wires 1 and 2 will be joined together and also 3 and 4, thus reversing the polarity of the circuit.

A SIMPLE SET OF TEST PRONGS

● THESE test prongs have the advantage of being flexible and can be spread to make any contact necessary in making circuit tests.

Cut two pieces of "tongue and groove" flooring so their grooves will come together when the pieces are matched.

Bare the ends of a long piece of double stranded electric cord. To one end attach two clips. To the opposite ends solder on two lengths of heavy string solder.

Place the insulated part of the cord in the groove of one piece of wood and bring the other against it and bind with electric tape.

This completes the test prongs as shown; they will be found mighty handy in making continuity and voltage tests around any radio circuit.—L. B. Robbins.

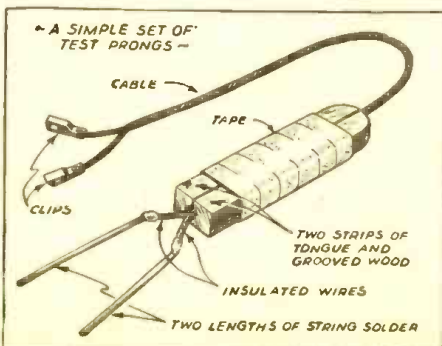

HERE IT IS...

the new Hallicrafters SX-32—the communications receiver I know you'll want!

13 tubes. Frequency coverage from 500 kc. to 40 mc. Adjustable noise limiter. Push-Pull high fidelity, audio output. 6 bands. Crystal phasing. Two stages of pre-selection. AVC BFD switch.

Get the best in short-wave reception! Your outmoded receiver is worth a liberal trade-in allowance from me, so drop me a line here at Butler and get my free estimate! Rock-bottom terms (financed by me to save you money) PLUS my liberal trade-in allowance make any receiver in my stock—the world's largest—with-in your easy reach.

Drop me a line today!

Bob Henry
W9ARA



HENRY RADIO SHOP
BUTLER, MISSOURI
WORLD'S LARGEST DISTRIBUTOR OF AMATEUR RECEIVERS



Readrite RANGER
MODEL 432-A

The Outstanding Tube Tester Value Checks all type tubes including Loctals, Bantam Jr., 1.4 volt Miniatures, Gaseous Rectifier, Ballast, High Voltage Series, etc. Filament Voltages from 1.1 to 110 volts. Direct Reading GOOD-BAD Meter Scale. Professional-appearing case with accessory compartment large enough for carrying Model 739 AC-DC Pocket Volt-Ohm-Milliammeter, thereby giving the serviceman complete testing facilities for calls in the field. . . . Model 432-A with compartment. Dealer Net Price \$20.78. Model 432-A in case less compartment \$19.65. Model 739, Dealer Net Price \$10.89.

WRITE FOR CATALOG—Section 1116 College Drive

READRITE METER WORKS, Bluffton, Ohio

END-FED Zepp for Receiving

R. H. Newkirk, W9BRD

Many valuable pointers are given by the author in this interesting article, describing the use of a simple antenna which will markedly improve your reception. Details of the proper tuning unit to use are also given.

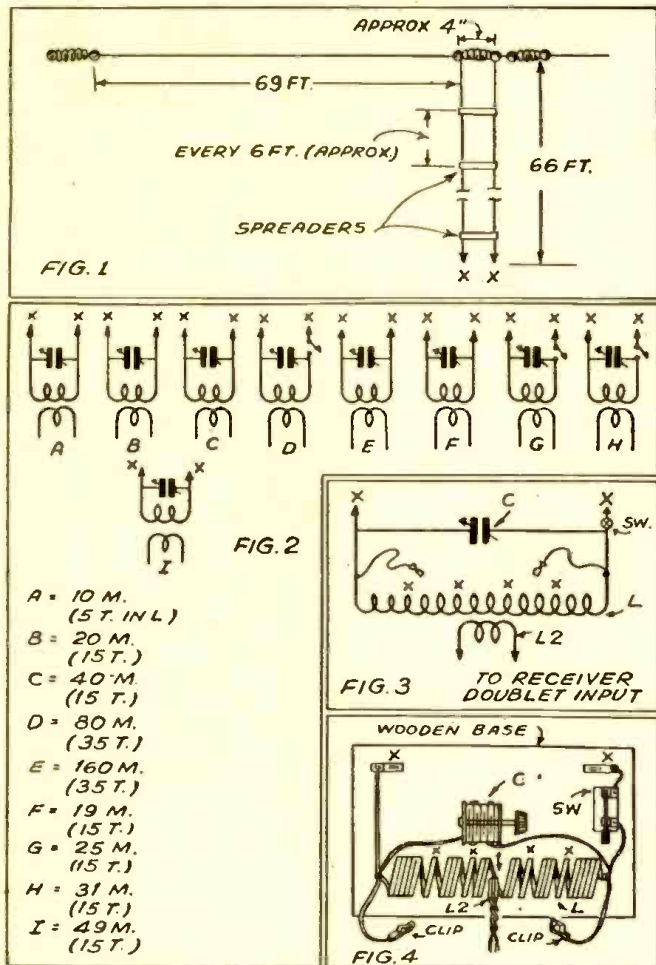

The illustration at the left shows the simple method of erecting and connecting the end-fed Zepp aerial for receiving purposes. How to tune it is explained in the accompanying article.

● IN an earlier article I sought to point out the advantages possessed by Zeppelin-type antennas for reception as compared to doublets or random-length wires. This dealt with an antenna combination for top performance in the larger *short-wave broadcast* bands and the ten and twenty meter amateur radiophone bands.

As pointed out, the chief advantages of the Zepp, especially the type fed in the center (also called "tuned doublet"), is its ability to resonate efficiently over a considerably wider band of frequencies than the doublet, and to operate on harmonics of the fundamental frequency (the frequency for which it is cut).

Center-feed was chosen for the purpose of resonating in the *short wave broadcast* bands because, as these bands do not occur in harmonic relation, its property of a more balanced resonance than the end-fed Zepp at frequencies slightly lower or higher than the frequency for which it is cut, or its harmonic frequencies, made it to be preferred.

A Zepp antenna for coverage of the *amateur* bands is a different proposition. The bands lie in quite good harmonic relation, and so one end-fed Zepp approximately 69 feet long (flat-top only) will operate efficiently on the 40, 20 and 10 meter ham bands. By use of feeders about 66 feet in length it is also possible to use the antenna as a Hertz on 80 and a Marconi on 160, resonating it in each band for best signal-to-noise ratio. (The 160 meter case is subject to exception as will be pointed out.)

Also, those interested in *BCB DX* can,

with a little experimentation, get the antenna to resonate in the broadcast band as a Marconi with a consequent improvement in reception.

Now, a few words on present *amateur band DX* listening may not be out of order. Recently ham DX has been much curtailed; in fact, English-speaking foreign stations in the *ham* bands are rare indeed. One still has our Pacific islands and other possessions to hunt for, but these are none too plentiful either.

S.W.L.'s Learn Spanish!

South American 'phone hams are still pounding through on the 20 and 40 meter bands, however, and the *short wave* listeners who have acquainted themselves with the Castilian alphabet and numerals are still adding to their DX logs. I know of many who never knew a word of Spanish before and who are growing quite proficient at the language, through their DX listening. Along this point also, it might be pointed out that our government has urged Americans in general to become more familiar with the Spanish tongue, in line with promoting closer Latin-American relations.

Of course, to learn a language fluently requires an able instructor. But a *short wave* receiver and a textbook can do a pretty fair job.

Anyway, not to digress further, there are still many DX stations in the ham bands to be logged by those who specialize in this branch of listening. Then, too, there is the embryo ham, who is just getting acquainted with the amateur frequencies and is learning

his code by daily amateur band sessions.

The antenna described here will be recognized by hams, as an ordinary Zepp. This type of "skywire" is perhaps the most widely used antenna on the 20 and 40 meter bands for amateur transmitting—and it makes just as good a *receiving* system as transmitting. It is used here at W9BRD for both purposes and, as is shown in Fig. 2, F, G, H and I, it can also be used to advantage in the *short wave broadcast* bands for reception. As has been said before, a Zepp meant only for receiving can be much less elaborate than one for transmitting. The insulation problem is minimized and wire size is unimportant.

The feed-line should be close to 66 feet in length, if tuning is to conform with that given in this article. Other lengths will require considerable cut-and-try experimentation in the tuning unit, in order to obtain resonance. Bending the feed-line when necessary should not cause complications if not carried to excess. Wooden spreaders or others of insulation material should space the feeders approximately four inches apart, from the end of the flat-top to the tuning unit. Other pointers on construction of Zepp feeders can be found in the article on the "Center-fed Zepp for Receiving." (See June issue of this magazine.)

Tuning Unit

Now for the *tuning unit*. It is diagrammed in Fig. 3 and pictured in Fig. 4. The coil, L, is wound of No. 12 enameled wire, self-supporting. Its diameter is approximately 2 inches. The clips extending from each end of the coil are used to "short out" the necessary turns when a smaller coil is desired. Three values of L are used; 35, 15 and 5 turns. Hence, L consists of 35 turns, close-wound, with provision made for shorting out portions of the coil. The enamel should be scraped clean from a section of the wire 10 turns from each end, and also 15 turns from each end. At these points the winding should be spaced a bit to enable the clips to grip. In the center of the coil should be a space just wide enough to admit the link coil, L₂. The link coil

could be wound around L but the spacing permits variation of coupling between the unit and the receiver by simply pulling L₂ in and out.

The link coil connects to the doublet input of the receiver, and consists of three turns of insulated wire of any size, about 1 3/4 inches in diameter. The smaller the wire the better, since less spacing will be necessary in the center of L.

The condenser, C, may be any variable receiving type condenser with a capacity of at least 200 mmf. If you use one with side trimmers, open these as far as possible, so that a low minimum capacity can be obtained. The single-pole single-throw switch, SW, is used to detach the reflecting, or "dummy" feeder, when it is desired to resonate the antenna for reception in the 80, 25 and 31 meter bands. The feeders connect to the tuning unit at the points marked X.

Normally, on 160 meters, one would tune 135 feet or so of wire against ground as a Marconi. But this antenna can be tuned to this band in the same manner as a Zepp, using a coil of approximately 35 turns. This provides good reception in the 1.7 mc. band but the antenna is not operating as an orthodox Zepp. Whether or not it operates as well as a Marconi would is not certain, but it is much simpler to adjust in this case. Those especially interested in 160 meter reception can determine this for themselves.

Tuning and adjusting a Zepp for reception was discussed in the article previously mentioned. The procedure is simple and for those who missed it I will go through it again.

We will take, for instance, the twenty meter band. With the receiver tuned to an amateur phone signal (be sure it isn't a broadcast image) and the tuning unit condenser at a random setting, insert the link, L₂, into the center of L as shown in Fig. 4. The received signal should be very weak. Now rotate C until there is a noticeable increase in signal strength. The point at which the signal is loudest is the point of resonance for the Zepp. Now decrease the coupling by pulling the link gradually out of L until optimum coupling is reached. This is the minimum amount of coupling possible with maximum signal strength.

Too much or tight coupling at this point will cause the resonance point on the condenser to become broad and will decrease the signal-to-noise ratio. Too little coupling will cause the signal strength of received signals to drop. This variation of coupling gives you an effective R.F. gain control if your receiver is not already equipped with such.

Once the knack of making this adjustment is learned you will be able to switch the antenna from one band to another in a jiffy.

This antenna makes a very good transmitting wire for work on all bands from 160 to 10 meters in restricted locations, where longer wires are not possible. Efficiency is highest on 40, 20 and 10 meters where it operates as a Zepp, but all states have been worked on 80 meters, using less than 100 watts. On 160 meters both coasts have been contacted on CW with 15 watts input, the 135 feet of wire tuned against a radiator ground as a Marconi.

SUPER SPECIALS

All of the attractive items listed here are brand new. ALL are in PERFECT WORKING ORDER. In many cases, the parts alone total more than the price we are asking. 100% satisfaction guaranteed or your money refunded.

ORDER FROM THIS PAGE. Use the convenient coupon below. Include sufficient extra remittance for parcel post charges, also order shipped express, collect. Any excess will be refunded. C.O.D. shipments require 20% deposit. If full remittance accompanies order, deduct 2% discount. Send money order, certified check, new U. S. stamps. No C.O.D. to foreign countries.

ORDERS TODAY LIMITED QUANTITIES PROMPT SHIPMENTS ASSURED

THE RADIUM SPINTHARISCOPE WORLDS DESTROYED BEFORE YOUR EYES



THE SPINTHARISCOPE is without question one of the most amazing scientific instruments ever invented. For ages scientists thought that atoms were indestructible. Yet the SPINTHARISCOPE demonstrates that radium actually destroys atoms. Look into the SPINTHARISCOPE and behold a most astonishing sight. You see a whole armament lit up like a brilliant night sky. You observe thousands of "flashes" and untold bright flashes similar to showers of shooting stars. Every flash is the result of the destruction of one atom of radium. As each radium atom disintegrates, it creates a Helium atom which it shoots out like a bullet at the terrific speed of 10,000 miles a second. These fast moving Helium atoms (also called Alpha rays) produce a minute flash of light when they strike a crystal of zinc sulphide contained in the SPINTHARISCOPE. The magnifying lens of the instrument makes these flashes visible to your eye and you actually see the perpetual movement of the tiniest particles of matter known to science. The action keeps on going, not only for a few minutes, or days, but actually for over 3,800 years, never stopping. Thus, the Radium in the SPINTHARISCOPE, if preserved, will outlive you and many succeeding generations.

Our SPINTHARISCOPE actually contains a small quantity of radium. If you want to see a most awe-inspiring sight, witness the actual destruction of thousands of worlds (atoms are miniature worlds), by simply looking through the lens of the instrument. See RADIUM DISINTEGRATED RIGHT BEFORE YOUR EYES. The RADIUM SPINTHARISCOPE, Price, Postpaid... 50c

VARIABLE SPEED UNIVERSAL MOTOR FOR 110 VOLTS, A.C. OR D.C.

Made for Dictaphone machines by American Gramophone Co. Used, but in excellent condition. Special lever control permits variable speeds up to 8000 r.p.m. 1/2" shaft extends from both sides of motor. Measures 7 1/2" x 3 1/4" diam. overall. Shp. Wt. 6 1/2 lbs.

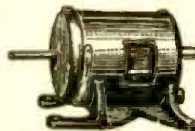

ITEM NO. 11
Your Price ... \$1.55

AMAZING BLACK LIGHT!! Powerful 250-Watt Ultra-Violet Bulb



The best and most practical source of ultra-violet light for general experimental and entertainment use. Makes all fluorescent substances brilliantly luminescent. No transformers of any kind needed. Fits any standard lamp socket. Made with special filter glass permitting only ultra-violet rays to come through. Brings out beautiful opalescent hues in various types of materials. Swell for amateur parties, plays, etc., to obtain unique lighting effects. Bulb only. Size of bulb. Shp. Wt. 1 lb.

ITEM NO. 67
YOUR PRICE ... \$2.00

POWERFUL ALL-PURPOSE INDUCTION MOTOR IDEAL FOR EXPERIMENTERS—101 USES

Sturdily constructed to precision standards, this self-starting shaded pole A.C. induction motor is powerful enough for a large variety of uses. Some of these are: Automatic Timing Devices, Current Interrupters, Electric Fans, Electric Chimes, Window Displays, Photocell Control Devices, Electric Vibrators, Small Grinders, Buffers and Polishers, Miniature Pumps, Mechanical Models, Sewing Machines, Phonograph Motors, Coffee Grinders, Motion Picture Projectors, Motorized Valves, Sirens, and other applications. Consumes about 15 watts of power and has a speed of 3,000 r.p.m. When geared down, this sturdy unit will constantly operate an 18-inch turntable loaded with 200 lbs. dead weight—THAT'S POWER! The motor is of midjet dimensions, 3 inches high by 2 inches wide by 1 1/2 inches deep; has 4 convenient mounting studs; shaft in 3/8" long by 3/16" diameter, and runs in self-aligning, oil-retaining bearings; the best materials. Perfect precision assembly and rigid inspection certify to its high quality, and assure long life. Designed for 110-20 volts, 50-60 cycles, A.C. only.

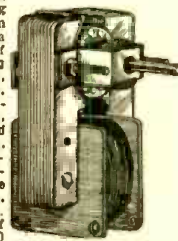

ITEM NO. 147
YOUR PRICE ... \$1.29

WESTINGHOUSE WATTHOUR METER

Completely overhauled and ready for immediate service. Designed for regular 110-volt 60 cycle 2-wire A.C. circuit. Servicemen use it in their shops to check current consumption of sets, soldering irons, etc. Keeps costs down. If dismantled, the parts alone would bring the price. The elaborate gear train could be used for metering on machines of various kinds. Simple to install; 2 wires from the line and 2 wires to the load. Sturdily constructed in heavy metal case. Size: 8 1/2" high, 6 1/2" wide, 5" deep, overall. Shp. Wt. 14 lbs.

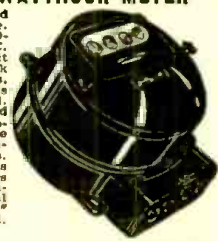

ITEM NO. 33
Your Price ... \$4.50

ELECTRIC HUMIDIFIER FOUNTAIN

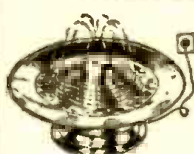

Adds healthful moisture to the air in winter. Evaporates as much as a pint of water in 24 hours. Fountain is 14" in diam. Sprays 8 streams of water 5" above fountain head. Made of spun aluminum. Comes in five colors: Bronze, chrome, copper, red, green. No water connection required. Just plug into 110 volt, 60 cycle

A.C. outlet. Current consumption few cents a month. Complete with base switch and 8 ft. power cord. Shipping wt. 9 lbs. List price \$14.95. Only a limited supply on hand.

ITEM NO. 125
YOUR PRICE ... \$4.95

100 POWER TELESCOPE LENS KIT



Make your own high powered 6 ft. telescope! Now you can thrill to a closeup view of the worlds out in space. See the rings around Saturn, the mountains of the moon! Kit contains 3" diam., 75" focal length, ground and polished objective lens and 2 astronomical eye-pieces, magnification 50x and 100x. Complete kit with full instructions.

ITEM NO. 123
YOUR PRICE ... \$1.95

NEW—EXTRA LARGE LENS KIT—contains completely finished 4" diameter 100" focal length ground and polished objective lens, three 1 1/2" diameter eye-pieces giving 66x, 133x, and 200x, an aluminum diagonal for overhead viewing, and a color filter for insertion in any eyepiece.

ITEM NO. 123L
YOUR PRICE ... \$3.95

HUDSON SPECIALTIES CO., 40 West Broadway, N. Y. C.

IT'S EASY TO ORDER—CLIP COUPON—MAIL NOW ORDER FROM THIS PAGE.

HUDSON SPECIALTIES CO., 40 West Broadway, Dept. RC-1141, New York, N. Y.

I have circled below the numbers of the items I'm ordering. My full remittance of \$..... (include shipping charges) is enclosed.

OR my deposit of \$..... is enclosed (20% required), ship order C.O.D. for balance. No C.O.D. order for less than \$2.00. (New U. S. stamps, check or money order accepted.)

Circle Item No. wanted: 11, 33, 67, 123, 123L, 125, 147, 148

Name Address

City State

Send remittance by check, stamps or money order; register letter if you send cash or stamps.

RADIO COURSE BOOK

FOR HOME-STUDY

ONLY
**12¢ A
LESSON**

**RADIO
SERVICING
COURSE
MANUAL**

**AMAZING
OFFER**
This is your chance to improve your radio knowledge. These easy-to-understand lessons, with 317 pictures, diagrams, and illustrations, cover every phase of radio repairing.

22 Large Lessons
243 Practical Hints
Data on 210 Tubes
Size: 8 1/2 x 11"
Printed in 1941

Learn quickly how to test radio parts, trace circuits, repair all types of radio sets using modern methods and equipment.
RADIO REPAIRING SIMPLIFIED
This home-study course manual has helped others like you to secure work in radio servicing, transmitter operation, national defense. These money-saving lessons will give you the training needed. Includes extra information on short-wave, television, signal-tracing, and auto radios. You may examine the complete course-book, containing all the lessons and review questions, in your own home without any risk or obligation.

PRACTICAL INSTRUCTIONS
The lessons are practical, clear, interesting, easy to master and use. Fine for review and brush-up on the latest in radio. Will pay for itself on the first couple of jobs. You will enjoy learning important practical facts and doing radio work as an expert.

"You should get more money for the course. The first week I studied. I made \$10.00 repairing sets. I have repaired 100 radios to date."
Robert C. Hammel, Davenport, Iowa.

"I started to repair radios when I was on the 12th lesson. It took me two months to master your course."
Roger Lankford, Montreal, Canada.

SATISFACTION GUARANTEED
Take advantage of our "no risk" trial offer. Send only 25c now. You will receive the complete Radio Course Book for 10 days examination. Begin your radio study or review without obligation. If you are pleased the complete Course Manual is yours to keep for only \$2.50, full price. Send coupon with 25c now—use the first lessons this week.

25c TRIAL ORDER COUPON

SUPREME PUBLICATIONS, 326 S. Jefferson St., Chicago, Ill.
Ship the complete "Radio Course Book" for 10 days use. I am enclosing 25c in coin or stamps and will deposit \$2.25, and a few cents postage, with the mailman. I must be satisfied or you will refund my money in full.

Name RC-D-C
Address
Send \$2.50 now and receive complete Manual postpaid. You save postage.

OPPORTUNITY UNLIMITED

awaits the far-thinking individual who prepares now for the increased pay positions in the Army, Navy, or Commercial Communications field. A serious shortage of trained code operators in each of these fields is your guarantee of a promising future—if you are properly trained.

BE SMART—start your training NOW right in your own home. Learn code the practical way, the easy way—the famous CANDLER way!

THIS COUPON ENTITLES YOU TO YOUR FREE COPY OF THE FASCINATING 52-PAGE BOOK OF FACTS. SEND FOR IT NOW!

CANDLER SYSTEM COMPANY, Dept. S112 BOX 926, DENVER, COLORADO

Please rush me my free copy of the 52-page BOOK OF FACTS. I understand I will not be obligated in any way.

NAME
STREET AND NO.
CITY STATE

SOLAR RED-CAPS
Smaller Diameter Dry Electrolytics
SPEED Servicing
Write for Catalog
SOLAR MFG. CORP. Bayonne, New Jersey

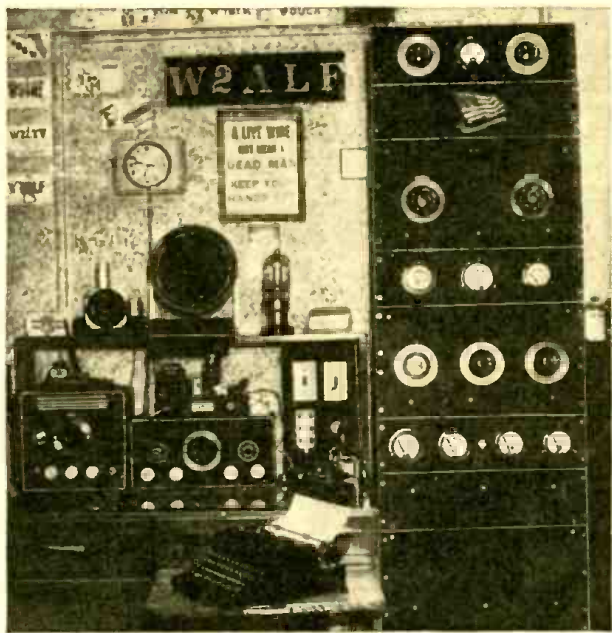
The pictures above and at the left show Henry J. Mennella, W2ALF of Brooklyn, N. Y., and his efficient-looking amateur radio station.

"Honor" Plaque Awarded To Henry J. Mennella, W2ALF

For Best HAM Station Photo

● HERE is station photo of W2ALF. The transmitter is a home-made affair, consisting of a 6L6 xtal oscillator, 809 buffer and a pair of HK54's; push-pull "final" is Class "C"; amplifier running 400 watts input.
The xtal, buffer and "final" stage each have their own plate power-supplies, and also a heavy duty bias supply for the final stage.
All grid and plate circuits are individually

metered; the output of the final terminates in an antenna impedance-matching network.
The receiver is a home-made 6 tube super-heterodyne. To the left of the receiver in the photo, is a freq-meter monitor and freq-standard, using the Browning circuit.
Directly above the monitor is a home-made audio oscillator, used for group code practice purposes. The "mill" shown is a Remington Portable.—Henry J. Mennella, 706 Berkely Place, Brooklyn, N. Y.

Here is the new "Award of Honor" Plaque which measures 5" x 7" in size. It is handsomely executed in colors on metal, and is framed, ready to hang on the wall. The name of the winner will be suitably inscribed.

Note These Important Rules

Attach a brief description not longer than 300 words, describing the general line-up of the apparatus employed, the size, type and number of tubes, the type of circuit used, name of commercial transmitter—if not home-made, watts rating of the station, whether for c.w. or phone or both, etc., also name of receiver.

State briefly the number of continents worked, the total number of stations logged or contacted, and other features of general interest. Mention the type of aerial system and what type of break-in relay system, if any.

Important—Enclose a good photograph of yourself, if your likeness does not appear in the picture!
You do not have to be a reader of RADIO & TELEVISION in order to enter the contest. Address all photos and station descriptions to Editor, Ham Station Photo Contest, c/o RADIO & TELEVISION, 25 West Broadway, New York, N. Y.

Index to advertisers

PUBLISHERS

Theo. Audel & Company.....310
 Data Print Company.....271
 Maedel Publishing House.....303
 Nelson Company.....261
 Radio & Technical Publishing Co.
 Inside Back Cover
 Radio Publications.....319
 Supreme Publications.....318

RADIO PARTS

Aerovox Corporation.....296
 Biley Electric Company.....310
 Bud Radio, Inc.....295
 C. F. Cannon Company.....301
 General Transformer Corp.....285
 Hammarlund Mfg. Co., Inc.....299
 International Resistance Company.....301
 James Millen Mfg. Co., Inc.....303
 Meissner Mfg. Co.....290
 National Company, Inc.....307, 320
 Ohmite Mfg. Company.....311
 Par-Metal Products Corp.....304
 Solar Mfg. Corp.....318
 Sprague Products Company.....295, 313
 Thordarson Elec. Mfg. Co.....311
 X. L. Radio Laboratories.....313

RADIO SETS

ABC Radio Laboratories.....310
 Allied Engineering Institute.....287
 Goldentone Radio Company.....290
 Hallicrafters, Inc.....291
 Midget Radio Company.....310
 Midwest Radio Corp.....287

RADIO SUPPLY HOUSES

Allied Radio Corp.....269
 Burstein-Applebee Company.....290
 Gold Shield Products Company.....315
 Harrison Radio Company.....281
 Henry Radio Shop.....315
 Hudson Specialties Company.....817
 Peerless Sound & Radio Corp.....286
 Radolek Company.....290
 Wholesale Radio Laboratories.....275

SOUND AND RECORDING EQUIPMENT

Amperite Corporation.....Inside Front Cover
 Amplifier Company of America.....287, 313
 Duotone Radio Company.....302
 Int. Tel. & Radio Labs.....290
 John Meck Industries.....290
 University Laboratories.....290

SCHOOLS AND CODE INSTRUCTION

American Radio Institute.....261
 Ayers Automatic Code Machines.....310
 Candier System Company.....318
 Capitol Radio Institute.....261
 Commercial Radio Institute.....261
 Coyne Electrical School.....260
 Dodge's Institute.....260, 310
 Instructograph Company.....261
 Lincoln Engineering School.....261
 Mass. Radio School.....261
 Midland Radio & Television School.....304
 National Radio Institute.....257
 National Schools.....260
 New York Y.M.C.A. Schools.....261
 Port Arthur College.....261
 Radio-Telio Institute.....261
 Radio Training Association.....261
 RCA Institutes, Inc.....260
 Sprayberry Academy of Radio.....259
 Teleplex Company.....310

TEST EQUIPMENT

Radio City Products Company.....279
 Readrite Meter Works.....315
 Supreme Instruments Corp.....302
 Triplett Elec. Instruments Company.....271
 Weston Elec. Instrument Corp.....278

TUBES

Hygrade Sylvania Corp.....296, 303
 National Union Radio Corp.....Back Cover

MISCELLANEOUS

Chartered Institute of American Inventors.....313
 Classified Section.....303
 Kato Engineering Co.....301
 Lancaster, Allwine & Rommel.....303
 Microtube Laboratories.....279
 Radio Corp. of America.....262
 Rosierucian Order.....290

(While every precaution is taken to insure accuracy, we cannot guarantee against the possibility of an occasional change or omission in the preparation of this index.)

10 BEST RADIO BOOKS 10^c ea.

RADIO FANS EVERYWHERE—these fine ten cent text books give you an excellent foundation for the study of RADIO. They are clearly written, profusely illustrated and contain over 15,000 words in each book. You'll be

amazed at the wealth of information contained in these handy books. Excellent for reference—ideal for every technical library. YOUR MONEY BACK if you are not satisfied. PROMPT SHIPMENTS

No. 1—HOW TO BUILD FOUR DOERLE SHORT WAVE SETS

No. 2—HOW TO MAKE THE MOST POPULAR ALL-WAVE 1- AND 2-TUBE RECEIVERS

No. 3—ALTERNATING CURRENT FOR BEGINNERS

No. 4—ALL ABOUT AERIALS

No. 5—BEGINNERS' RADIO DICTIONARY

No. 6—HOW TO HAVE FUN WITH RADIO

No. 7—HOW TO READ RADIO DIAGRAMS

No. 8—RADIO FOR BEGINNERS

No. 9—SIMPLE ELECTRICAL EXPERIMENTS

No. 10—TELEVISION

BOOKS ARE ALL UNIFORM

Every book in the GERNSBACH EDUCATIONAL LIBRARY has 32 pages—with illustrations varying from 50 to 66 in number. Each title volume contains over 15,000 words. Positively radio's greatest book buy! If you do not think these books worth the price asked, return them in 24 hours and your money will be instantly refunded.

RADIO PUBLICATIONS • 25 WEST BROADWAY • NEW YORK, N. Y.

RADIO PUBLICATIONS, Dept. RC-11-41
 25 WEST BROADWAY, NEW YORK, N. Y.

Gentlemen: Please send immediately, POSTPAID, the book numbers circled below. I am enclosing cents —each book being 10c.

1 2 3 4 5 6 7 8 9 10
 NEW NEW

Send FREE listing of 48 new 10c publications.

Name Address

City State

Remit by check or money order—register letter if you send cash or unused U. S. postage stamps.

MAIL COUPON TODAY!

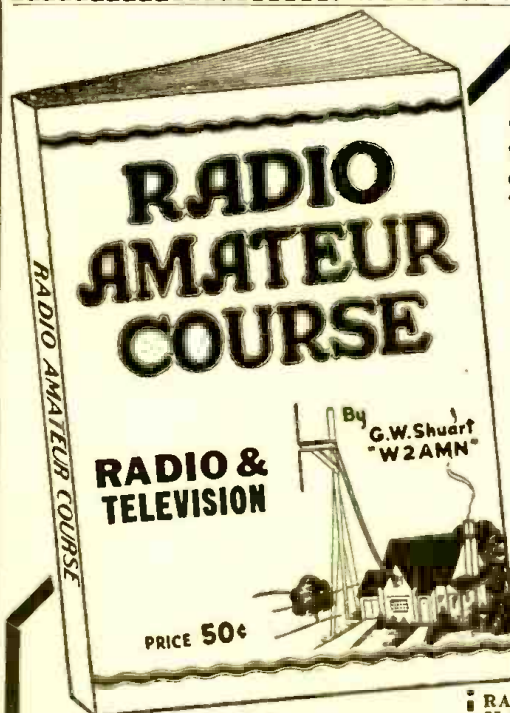

Your Money Back—

If the RADIO AMATEUR COURSE does not represent the greatest book value ever offered to the radio "fans" for 50c

To convince you that there isn't a better book buy today, the publishers of the RADIO AMATEUR COURSE make the sensational offer of a money-back guarantee on such a low-priced book. Stop in at any of the many dealers handling this book and examine it. See for yourself if the RADIO AMATEUR COURSE isn't just the book you've always wanted.

Printed on the finest coated paper—well illustrated attractive 4-color cover—complete with radio information you must have. It contains a step-by-step program for obtaining a short-wave radio education.

Written by George W. Shuart, W2AMN, foremost short-wave authority

RADIO AND TELEVISION
 25 West Broadway, New York, N. Y.

Gentlemen: I enclose herewith my remittance of Fifty Cents (50c) for which please send me POSTPAID, my copy of the RADIO AMATEUR COURSE. (Remit by check or money order; register letter if you send cash or unused U. S. Postage stamps.)

Name

Address

City State R&T-11-41

148 PAGES

6 1/4 x 9 1/2 INCHES

OVER 150 RADIO DIAGRAMS and TECHNICAL PHOTOGRAPHS

RADIO AND TELEVISION

25 West Broadway New York, N. Y.



NC-45

THE NC-45

Series valve noise limiter with automatic threshold control.
 Improved AVC Circuit.
 Eight tube superheterodyne circuit.
 Full vision dial with separate bandsread condenser.
 Tone control.
 CW Oscillator.
 Four range coil switch, 550 KC to 30 MC.
 Three models for batteries, for AC-DC and for AC only.

Amateur Net Price \$57.50
 including speaker and tubes

THE NC-200

Sensitivity better than one microvolt.
 Series valve noise limiter.
 Improved crystal filter with rejection ratios as high as 10,000 to 1.
 Stability 3 parts in 100,000 for 20 volt line fluctuation.
 AC line or portable operation.
 Speaker in matching cabinet.

Amateur Net Price \$159.50
 without speaker

NC-200



agers are: Publisher Radcraft Publications, Inc., 25 West Broadway, N. Y. Editor, H. Gernsback, Managing Editor, H. W. Secor. Business Managers, None.

2. That the owner is: (If owned by a corporation, its name and address must be stated and also immediately thereunder the names and addresses of stockholders owning or holding one per cent or more of total amount of stock. If not owned by a corporation, the names and addresses of the individual owners must be given. If owned by a firm, company or other unincorporated concern, its name and address, as well as those of each individual member, must be given.) Radcraft Publications, Inc., 25 West Broadway, New York, N. Y., H. Gernsback, 25 West Broadway, New York, N. Y.

3. That the known bondholders, mortgagees, and other security holders owning or holding 1 per cent or more of total amount of bonds, mortgages, or other securities are: (If there are none, so state.) None.

4. That the two paragraphs next above, giving the names of the owners, stockholders and security holders, if any, contain not only the list of stockholders and security holders as they appear upon the books of the company but also, in cases where the stockholder or security holder appears upon the books of the company as trustee or in any other fiduciary relation, the name of the person or corporation for whom such trustee is acting, is given; also that the said two paragraphs contain statements embracing affiant's full knowledge and belief as to the circumstances and conditions under which stockholders and security holders who do not appear upon the books of the company as trustees, hold stock and securities in a capacity other than that of a bona fide owner; and this affiant has no reason to believe that any other person, association, or corporation has any interest direct or indirect in the said stock, bonds, or other securities than as so stated by him.

5. That the average number of copies of each issue of this publication sold or distributed, through the mails or otherwise, to paid subscribers during the twelve months preceding the date shown above is..... (This information is required from daily publications only.)
 H. Gernsback, Publisher.

Sworn to and subscribed before me this 1st day of October, 1941.

[Seal] Maurice Coyne, Notary Public.
 Commission expires March 30, 1942

STATEMENT OF THE OWNERSHIP, MANAGEMENT, CIRCULATION, ETC., REQUIRED BY THE ACTS OF CONGRESS OF AUGUST 24, 1912, AND MARCH 3, 1933
 Of Radio-Craft, Incorporating Radio & Television Published Monthly at Springfield, Mass., for October 1, 1941.
 State of New York }
 County of New York } ss.
 Before me a Notary Public in and for the State and county aforesaid, personally appeared H. Gernsback, who, having been duly sworn accord-

ing to law, deposes and says that he is the Editor of Radio-Craft, Incorporating Radio & Television and that the following is, to the best of his knowledge and belief, a true statement of the ownership, management (and if a daily paper, the circulation), etc., of the aforesaid publication for the date shown in the above caption, required by the Act of August 24, 1912, as amended by the Act of March 3, 1933, embodied in section 537, Postal Laws and Regulations, printed on the reverse of this form, to wit:
 1. That the names and addresses of the publisher, editor, managing editor, and business man-

PARTIAL LIST OF CONTENTS

How to align Superheterodynes
 Condenser replacement chart
 All RMA color codes
 I-F "peaks" of 20,173 superhets
 Trouble "case histories" for 4,607 receivers and record changers
 Portable receiver replacement battery charts
 Socket connect. diagrams of 970 tubes
 Operating characteristics of 970 tubes
 Grid-bias resistors for 297 tubes
 Power transformer design chart
 Volume & tone control circuits
 Vibrator buffer condenser chart
 Decibel tables
 How to modernize old receivers
 Home and auto-radio trouble-shooting charts
 Reactance charts
 Important radio & servicing formulae
 Radio trade directories
 Radio & physical conversion units, etc., etc.

THE GREAT NEW BOOK THAT WILL BRING

**MORE PROFIT!
 TO YOU!**

**GHIRARDI'S
 REVISED AND ENLARGED RADIO**

**Troubleshooter's
 HANDBOOK**

Completely revised, with 400 pages of brand new data, never before published, this big NEW Troubleshooter's Handbook covers the entire field of radio servicing. Here is all the information you need to do your service work more speedily. Reference is easy and fast . . . from years of experience A. A. Ghirardi knows exactly what data you servicemen need in your work today. And here, skillfully assembled, tabulated, charted, indexed and boiled down to essentials is today's biggest store of working service information in Large Legible Type, with bold subject captions—for split-second reference to **SAVE YOU SERVICING TIME and TO ADD TO YOUR PROFIT!** It's all new and different! No matter how many manuals and data books you now own, you will want the fastest, completest, most practical servicing reference handbook of them all—Ghirardi's!

**OVER 400 PAGES
 OF BRAND NEW "DOPE"
 710 BIG 8½ x 11 PAGES IN ALL!**

NOW ONLY \$3.50

**Use Our 5-Day Trial Plan
 YOU MUST BE SATISFIED!**

Prices going up Jan. 1st. Order Now and Save!

Save Trouble-shooting Time

Cut down your trouble-shooting time with the greatest compilation of case histories ever published. Common trouble symptoms and remedies for over 4,600 models of home and auto sets and record changers . . . all carefully indexed and arranged for instant reference.

Save Repair Time

I-F alignment peaks of 20,173 superhets, I-F transformer troubles, servicing and replacement. "Plug-in" and "ballast" resistor replacement and RMA color code charts. 20-page tube chart. Modernizing old receivers. Loads of other tables, charts, etc.

Save Labor

Do you spend precious hours hunting up data required for servicing that gosh-darned complicated job in the shop? You can't but help save valuable time all-around with this new, revised, up-to-the-minute encyclopedia of important, necessary data. Order a copy now.

(Your local distributor can supply you with the new Radio Troubleshooters' Handbook)

FREE!! UP-TO-THE-MINUTE COLOR CODE WALL CHART

Send for your FREE copy of Ghirardi's new, easy-to-read Capacitor and Resistor color code chart. It's original . . . the only one of its kind we know of . . . gives all the RMA coding arrangements at a glance.

MORE GHIRARDI VOLUMES!

RADIO PHYSICS COURSE

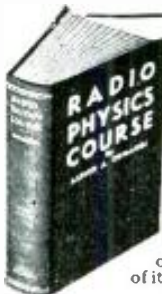

Selected as a training text for the U.S. Army and Navy, this Ghirardi book can help fit you . . . at home . . . in spare time for high-pay radio jobs. Between the covers of this 972-page volume is one of the most intensive technical training courses in radio, sound, electricity and television. Designed for study at home—it is so simple and easy to understand that you need no previous radio background, not even a knowledge of math. The course complete, think of it, only \$4.00.

MODERN RADIO SERVICING



A. A. Ghirardi has packed years of servicing experience into the 1300 pages of this training book. Starting with a complete 420 page treatment of servicing instruments, he takes you step by step through the actual procedure of profitable trouble-shooting, testing and repairing of all makes of radio sets. More than a practical "how to" book, it's so easy to understand that you can study servicing at home. (Check your progress with the 720 review questions.) A gold mine for you, and the price is just \$4.00.

SAVE MONEY! Here is your opportunity to get two great Ghirardi servicing books—Modern Radio Servicing and the famous just-off-the-press Troubleshooter's Handbook—at the money-saving price of \$7.00. Not only do you pocket real money, but you get the complete serviceman's library . . . the two books that give you everything in profitable servicing from A to Z—over 2,000 pages of practical servicing information!

MODERN RADIO SERVICING \$4.00 plus RADIO TROUBLE-SHOOTER'S HANDBOOK \$3.50 . . . now only \$7.00. Rush the coupon this minute!

**RADIO & TECHNICAL PUBLISHING CO., Dept. RC-111,
 45 ASTOR PLACE, NEW YORK, N. Y.**

- Enclosed find payment for books I have checked (on 5-day trial)
- Revised Radio Troubleshooter's Handbook \$3.50 (\$4 foreign)
 - Modern Radio Servicing \$4. (\$4.50 foreign)
 - The above two combined in your SPECIAL OFFER \$7. (\$8 foreign)
 - Radio Physics Course \$4. (\$4.50 foreign)
 - Rush my FREE COLOR CODE CHART Rush FREE literature.

NAME.....
 ADDRESS.....
 CITY.....
 STATE.....

**5 DAYS
 AT OUR RISK**

**Go to Your Dealer
 or Mail This Coupon Now**

WHERE YOU FIND
 NATIONAL UNION
 YOU FIND
 Better RADIO SERVICE



Granada Radio Service, 900 E. 14th St., Oakland, California
 (Mr. Fred Rock and assistant)

The National Union Equipment program has made it possible for me to have the best equipped shop in town.

NATIONAL UNION invites all radio service dealers to enjoy the benefits of the **N. U. SHOP EQUIPMENT PLAN**. The latest in tube testers and test equipment are available to you, immediate delivery. More than 50,000 completed deals prove the success of this plan. Investigate Now.

ADDITIONAL PRODUCTS . . .

PANEL LAMPS
 EXCITER LAMPS
 PHOTO ELECTRIC CELLS
 DRY BATTERIES

CATHODE RAY TUBES
 SOUND EQUIPMENT
 SOUND ACCESSORIES
 FLASH LIGHT BULBS

Ask Your N.U. Distributor or Write

NATIONAL UNION RADIO Corp.

57 STATE STREET
 NEWARK, N. J.



Radio Tubes

. . . More Radio Service Dealers use National Union than any other make . . . there must be a good reason why.



Condensers

Complete line . . . Same Super Quality as found in N. U. Tubes. Just try them.



Sound Extra Tubes

. . . a line of heavy duty radio tubes for sound work . . . an exclusive N. U. development.



Batteries

. . . The only line of Dry Batteries sold exclusively to the radio Trade . . . You can make more money.

ADV Plans, LLC

Copyright Notice:

The entire contents of this CD/DVD are copyright 2014 by ADV Plans, LLC. All Rights Reserved.

Reproduction or distribution of this disk, either free or for a fee is strictly prohibited. We actively monitor and remove listings on eBay thru Vero.

You are free to copy or use individual images in your own projects, magazines, brochures or other school projects.

Only the sellers listed here are authorized distributors of this collection:
www.theclassicarchives.com/authorizedsuppliers

Please view our other products at
www.theclassicarchives.com,
or our ebay stores:

[TheClassicArchives](#)
[ADVPlans](#)
[SuperShedPlans](#)

